

DPI 610 / 615 IS

Intrinsically Safe Portable Pressure Calibrator Instruction Manual

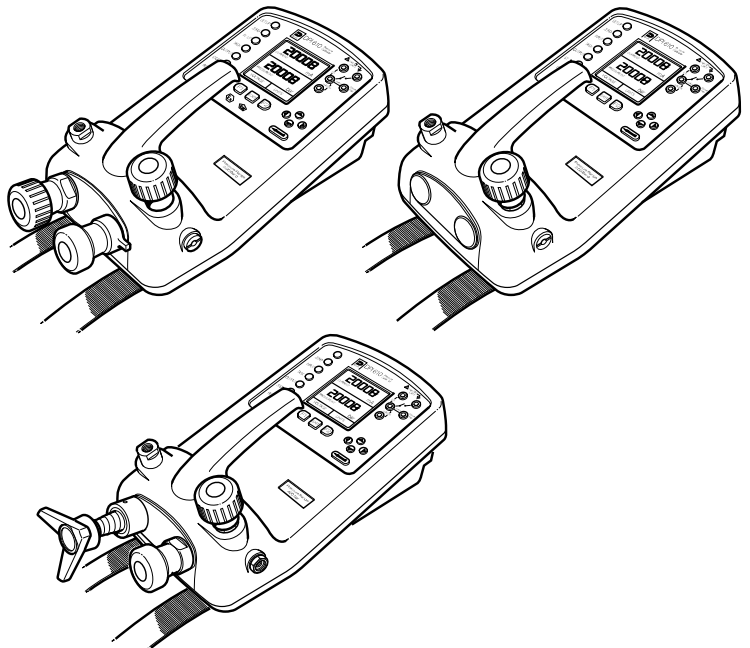

Safety



WARNING Before operating this intrinsically safe instrument, read the safety instructions and the special conditions of safe use.

Do not apply pressure greater the maximum safe working pressure to the sensor.

The manufacturer has designed this equipment to be safe when operated using the procedures detailed in this manual. Do not use this equipment for any other purpose than that stated.

This publication contains operating and safety instructions that must be followed to ensure safe operation and to maintain the equipment in a safe condition. The safety instructions are either warnings or cautions issued to protect the user and the equipment from injury or damage.

Use suitably qualified* technicians and good engineering practice for all procedures in this publication.

Maintenance

The equipment must be maintained using the procedures in this publication. Further manufacturer's procedures should be carried out by authorized service agents or the manufacturer's service departments.

Druck.com

For technical advice contact the manufacturer.

Symbols

Symbol	Description
	This equipment meets the requirements of all relevant European safety directives. The equipment carries the CE mark.
	This symbol, on the equipment, indicates a warning and that the user should refer to the user manual. Ce symbole, sur l'appareil, est un avertissement qui indique que l'utilisateur doit consulter le manuel d'utilisation.
	Do not dispose of this product as household waste. Use an approved organization that collects and/or recycles waste electrical and electronic equipment. For more information, contact one of these: - Our customer service department: Druck.com - Your local government office.



ATEX Approved Models

Introduction

These instructions detail the requirements for using the DPI 610 IS and DPI 615 IS intrinsically safe pressure calibrator in a hazardous area. Read the whole publication before starting.

* A qualified technician must have the necessary technical knowledge, documentation, special test equipment and tools to carry out the required work on this equipment.

Markings

 II 1 G Equipment group & category
 Ex ia IIC T4 Ga Hazardous location markings
 BAS02ATEX1174X Certificate number
 1180 CE Mark
 DPI 61X IS Specific apparatus type
 (Pressure Range in mbar or psi Full-scale pressure rating
 Druck LTD. Groby LE6 0FH, UK Manufacturer's name and address
 SN *****/YY-MM Serial number and date of manufacture, Year-Month.

Requirements and Conditions

Batteries



WARNING Only replace batteries in a safe area.

Power supply use only 6 x LR14 (C) batteries:

- Duracell MN1400-LR14
- Procell Industrial MN1400-LR14
- Energizer E93.KR14.C.AM2
- Energizer Industrial EN93
- Varta 4014 LR14.C.AM2

Special Conditions for Safe Use

1. The DPI 61X Series Pressure Calibrator is not capable of withstanding the 500 V RMS electric strength test between external connectors and frame of the equipment as required by EN 60079-11. This must be taken into account when using the equipment for input measurements in a system.
2. The outer enclosure may contain light metals in the form of aluminium, magnesium, titanium or zirconium. The equipment must be operated in such a manner as to prevent the possibility of it being subjected to impact or friction.

Note: Does not apply whilst the equipment is in transit within the optional carrying case.

Electrical Parameters

Maximum Output Parameters:

I _{in} (SK1 ^a)	V _{in} (SK2 ^a)	SwitchIn (SK3 ^a)
U _o = 1.1 V dc	U _o = 1.1 V dc	U _o = 1.1 V dc
I _o = 0.16 mA dc	I _o = 0.11 μA dc	I _o = 12 mA dc
P _o = 0.15 mW	P _o = 0.03 μW	P _o = 11 mW
C _i = 0.05 μF	C _i = 0	C _i = 0.05 μF
L _i = 0	L _i = 0	L _i = 0

- a. The output parameters at sockets SK1, SK2 and SK3 do not exceed the values specified in clause 5.7, Simple Apparatus, of EN 60079-11.

Input (SK6)	RS232	External Transducer
$U_o = 7.9 \text{ V dc}$	$U_o = 7.6 \text{ V dc}$	$U_o = 7.9 \text{ V dc}$
$C_i = 0$	$I_o = 82 \text{ mA dc}$	$I_o = 155 \text{ mA dc}$
$L_i = 0.1 \text{ mH}$	$P_o = 162 \text{ mW}$	$P_o = 0.43 \text{ W}$
	$C_i = 0$	$C_i = 0.15 \text{ }\mu\text{F}$
	$L_i = 0$	$L_i = 0.9 \text{ mH}$
	$U_m = 250 \text{ V}$	$C_o = 8.6 \text{ }\mu\text{F}$
		$L_o = 0.3 \text{ mH}$

Maximum Safe Input Parameters:

SK1, SK2, SK3 and SK6
$U_i = 30 \text{ V}$
$I_i = 100 \text{ mA}$
$P_i = 1.0 \text{ W}$

Installation



WARNING Do not use tools on the pressure calibrator that might cause incendive sparks - this can cause an explosion.

- Provide additional protection for equipment that may be damaged in service.
- Installation should be carried out by qualified plant installation technicians in compliance with the latest issue of EN 60079-14.

Declaration Requirements - EU Directive 2014/34/EU

The DPI 610 IS and DPI 615 IS pressure calibrators are designed and manufactured to meet the essential health and safety requirements not covered by the EU Type Examination Certificate BAS02ATEX1174X when installed as detailed above.

Contents

1.	Introduction	1
1.1	General	1
1.2	Description of Procedures	1
1.3	Using This Guide	2
1.4	Maximum Instrument Ratings	2
1.5	Operator Controls	3
1.6	Display	3
1.7	Hard Key Functions	4
1.8	Soft Keys	4
1.9	Cursor Keys	4
1.10	Electrical Connections	6
2.	Getting Started	7
2.1	Fitting Batteries	7
2.2	Switching On	7
2.3	Change Pressure Units	8
2.4	Voltage and Current Measurements	8
2.5	Typical Calibration Set-up (Pressure to Voltage)	9
2.5.1	General Procedure	9
2.6	Zero Display Reading	9
3.	Task Selection	11
3.1	Task Key	11
3.2	Using TASK Functions	11
3.3	Set Units	11
3.4	Cal Mode (DPI 615 versions only)	11
3.5	Basic Mode (Task BASIC)	12
4.	Taking Measurements	13
4.1	Pressure Transmitter (P-I) Task	13
4.2	Voltage Output Pressure Transmitter (P-V) Task	13
4.3	Pressure Converter (Pressure to Pressure) Task	14
4.4	Current to Pressure Converter (I-P) Task	15
4.5	Pressure Switch Test (P-SWITCH) Task	16
4.6	Pressure to Display (P-DISPLAY) Task	17
4.7	Leak Test (LEAK TEST) Task	18
4.8	Transmitter Simulator (TX SIM) Task	19
4.9	Relief Valve Test (REL VALVE) Task	20
5.	Advanced Task	21
5.1	General	21
5.2	Select Input	21
5.3	Ambient Temperature Measurement	21
5.4	Process Functions	21
5.4.1	Tare Process Function	22
5.4.2	Min/Max Process Function	23
5.4.3	Filter Process Function	23
5.4.4	Flow Process Function	24

5.4.5	% Span Process Function	24
5.5	Select Output	24
5.6	Electrical Outputs (Loop Power)	25
5.6.1	mA Step	25
5.6.2	mA Ramp	26
5.6.3	mA Value	26
5.7	Define New Task	27
5.8	Clear Task	27
6.	Memory Operations	29
6.1	Saving Display or Data Log	29
6.2	Store Operations (Screen Snapshots)	29
6.3	Recalling Stored Data (Screen Snapshots)	29
6.4	Data Log Operations	29
6.4.1	Auto Log (Timer)	30
6.4.2	Manual Logging	30
6.4.3	Recall Data Log Files	30
6.4.4	Uploading Data Log Files	31
6.4.5	Delete Datalog and Procedure Files	32
6.4.6	Downloading Procedure Files	32
6.4.7	Running Procedure Files	33
6.4.8	Recalling Data Files	33
7.	Using Set-up	35
7.1	General	35
7.2	Store Mode	35
7.3	Contrast	35
7.4	Settings - Select Setup Option	35
7.4.1	Units	36
7.4.2	Define Special Units	36
7.4.3	Language	36
7.4.4	RS232	37
7.4.5	Powerdown	37
7.4.6	Calibration	37
7.5	Date and Time (Real Time Clock)	38
7.5.1	Date Format	38
7.5.2	Set Date	38
7.5.3	Set Time	38
8.	Calibration	39
8.1	General	39
8.2	Calibration Check	39
8.3	Calibration Adjustment	39
8.4	Guide to Calibration Procedures	39
8.5	Test Equipment	40
8.6	Using the Calibration Menu	40
8.7	PIN security	41
8.7.1	Change PIN	41
8.8	Calibrate Internal Ranges	41
8.9	Internal Pressure Range	41
8.10	Voltage Input Range (5 V)	42
8.11	Voltage Input Range (30 V)	44

8.12	Current Input Range (55 mA)	46
8.13	Current Output Range (24 mA)	48
8.14	Ambient Temperature Channel	50
8.15	Calibrate External Sensors	51
8.16	Add External Sensor	53
9.	Hydraulic Calibrator Versions	55
9.1	Introduction	55
9.2	Safety Instructions	56
9.3	Preparation for Use	56
9.4	Bleeding the System	57
9.5	Operation	58
9.6	Draining the Hydraulic Fluid	58
9.7	Flushing - Refilling or Changing the Hydraulic Fluid	58
Appendix A.	Datalog File Example	61
A.1	Typical Uploaded Data Log File (DPI 610)	61
A.2	Typical Uploaded Procedure Data File (DPI 615)	62
A.3	Record Type	62
Appendix B.	“Quick Fit” Pressure Connector	63
B.1	Introduction	63
B.2	Connection Sequence	63

1. Introduction

1.1 General

The DPI 610 IS and DPI 615 IS intrinsically safe instruments measure and display pneumatic and hydraulic pressure applied to the test port. Pressure measurement can be absolute, gauge and sealed gauge and in ranges from 2.5 mbar to 700 bar (1.0 inH₂O to 10000 psi).

Calibrator versions of this instrument contain pneumatic or hydraulic pressure generation components to produce pneumatic pressure ranges between -1 to 20 bar (-14.5 psi to 300 psi) and hydraulic pressure ranges up to 400 bar (6000 psi).

Using external electrical connections, the DPI 610 IS and DPI 615 IS intrinsically safe instruments measure ± 30 V dc and ± 55 mA. An integral sensor provides measurement of ambient temperature. Additional sensors (option B1) connect to an external connector and extend the pressure measurement range and include differential pressure measurement. The DPI 615 instrument has an RS232 connector to enable downloading of test data to a compatible documenting system. Six alkaline C size batteries, IEC Type LR14, power the instrument.



INFORMATION Zinc-carbon and zinc-chloride cells must not be used in this instrument. Use only the battery types as shown in “Batteries” on page ii.

1.2 Description of Procedures

The procedures apply to both the DPI 610 IS and the DPI 615 IS instruments unless otherwise stated. In the procedures in this manual, hard (fixed function) and soft (variable function) key operations are shown in bold type: **TASK** and **F1**. These statements mean press the **TASK** key and press the **F1** key. Soft key operations can be assigned to both the **F1** and **F2** keys. Where a specific soft function is referred to it is written in bold italics (e.g.) ***PROCESS***.

This instrument has a number of operating modes that are described in simplified form in the following sections. Diagrams accompanying the procedures give typical selection sequences and shaded controls indicate that this control key should be pressed in the appropriate sequence. Diagrams should be read from left to right, top to bottom where appropriate. A shaded display soft box indicates that the function key immediately below that soft box should be pressed (either **F1** for the left hand soft box or **F2** for the right).

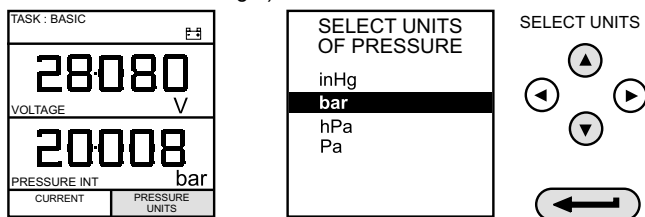





In the above diagram the following key sequence is indicated.

- Press the **F2** key (the key immediately below the ***UNITS*** soft box).
- Use the **Up** and **Down** cursor keys (only) to select the required option. (If all keys shaded, use all these keys to select or enter data).
- Press the **ENTER** key.

1.3 Using This Guide

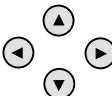
The following key symbols are used in the procedure diagrams:

Table 1-1: Key Symbols

Key	Description
	Shaded cursor keys indicate that a combination of these four keys, Up, Down, Left and Right should be used to (e.g.) enter an alpha numeric value or to select a function.
	Indicates the ENTER key. Used to confirm an operation or a selection. Shading indicates key operation.
	Exit key, used to clear current menu selection and return to next menu level above current level. Used as an escape key from current operation. Shading indicates key operation.
RECALL 	Hardkey (total 7). Legend beside key symbol indicates function. Shading indicates key operation.

1.4 Maximum Instrument Ratings

The following table shows the maximum measurement input ratings of the instrument which should not be exceeded.

Table 1-2: Maximum Instrument Rating

Parameter	Maximum Rating ^a
Pressure	120% of full-scale
Voltage	30 V dc
Current	55 mA dc

- a. The display flashes if the input pressure, voltage or current over-range.

1.5 Operator Controls

These divide into two groups, the operator/display controls (Figure 1-1 on page 3) and the pressure/vacuum generation components (Figure 1-2 on page 5). The operator controls and a typical display, common to all instrument versions, is shown below.

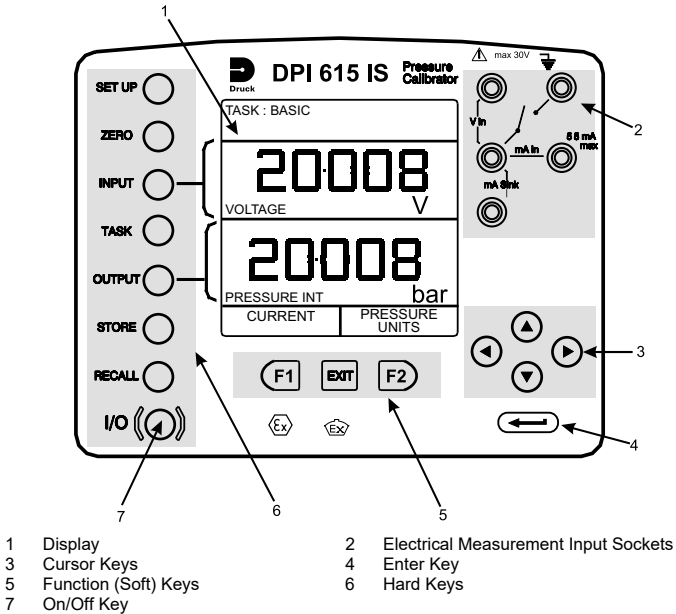

- | | | | |
|---|----------------------|---|--------------------------------------|
| 1 | Display | 2 | Electrical Measurement Input Sockets |
| 3 | Cursor Keys | 4 | Enter Key |
| 5 | Function (Soft) Keys | 6 | Hard Keys |
| 7 | On/Off Key | | |

Figure 1-1: DPI 610/615 IS Key-pad

1.6 Display

The display and key-pad of the instrument divides into four distinct sections. The two main sections of the display are used to show an input and an output. The remaining two sections show the status display area and define the soft key functions. A typical display is shown below:

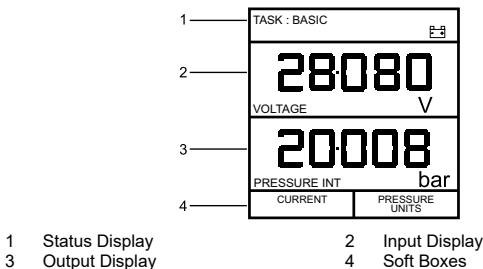

- | | | | |
|---|----------------|---|---------------|
| 1 | Status Display | 2 | Input Display |
| 3 | Output Display | 4 | Soft Boxes |

1.7 Hard Key Functions

Table 1-3: Hard Key Functions

Key	Function
I/O	This key selects the instrument ON and OFF.
SETUP ^a	The SETUP key provides access to the instrument's general configuration parameters that are set-up to certain default parameters on delivery.
ZERO	The ZERO key zeros either the selected input or output display, only if the display reading is within 5% of zero. Attempts to zero a larger offset result in an error message, Zero too large .
INPUT ^a	The INPUT key selects the input parameter to be displayed.
TASK	The TASK key rapidly configures the instrument for a number of different types of external device calibration. There are twenty task configurations available, eleven pre-programmed configurations and nine user defined configurations.
OUTPUT ^a	The OUTPUT key selects the output parameter to be displayed.
STORE ^a	Depending upon how the instrument's STORE mode is set-up, this key is used either to store up to 20 display screens in SNAPSHOT mode, or to manually log a screen in DATALOG mode.
RECALL ^a	This key recalls a previously stored screen to the display. Depending on the STORE mode set-up, operation of this key recalls either the snapshot of a previously stored screen or data log file. In STORE mode, selection displays the last screen stored. By using the cursor keys, the operator can scroll either forward or back through memory locations.
ENTER 	The ENTER key either enters data (accept entered data), or, in conjunction with the soft keys, accepts a given selection.
EXIT	The EXIT key operates in conjunction with all the other hard and soft keys to exit from the current screen or menu level, to the level immediately preceding it. To quit completely from any menu level, press EXIT until the MEASURE/SOURCE screen is displayed.

a. These key functions are not available in BASIC mode.

1.8 Soft Keys

Three soft keys, designated **F1**, **EXIT** and **F2**, are situated immediately below the display as shown below. These keys have their function allocated by the instrument software which is indicated in the bottom of the display (Voltage for **F1** and Units for **F2** in this example). They are used to select menu (program) options and are fully described under the appropriate section headings.

1.9 Cursor Keys

The cursor keys consist of a block of four keys, designated **up ▲**, **down ▼**, **left ◀**, and **right ▶**. In programs where options need to be selected from a list, (e.g.) the **TASK** selection program, the **up ▲** and **down ▼** cursor keys are used to highlight one of the options, from which it can be

selected by the **ENTER** key. In **TASK** mode, where more than one page of options are provided, the **left** ◀, and **right** ▶ cursor keys will switch between pages.

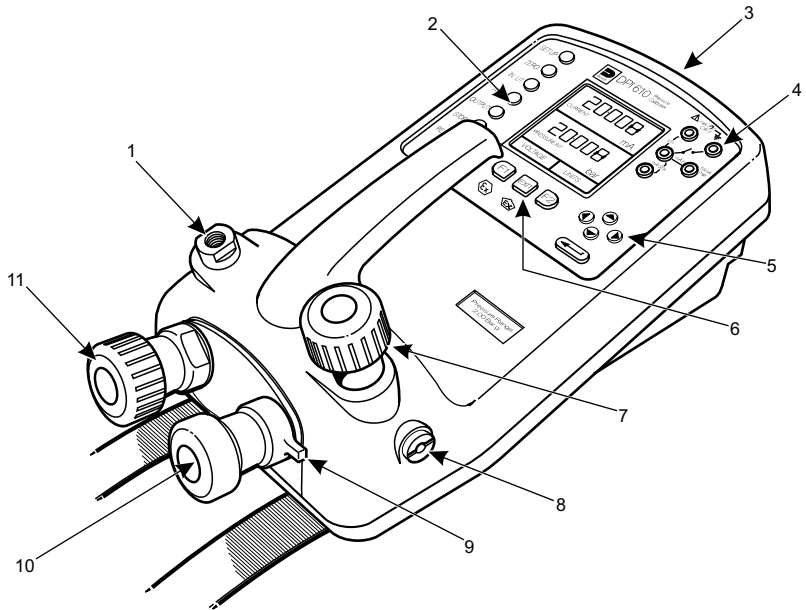

- | | | | |
|----|---|----|----------------------|
| 1 | Test port, connect to unit under test | 2 | Hard keys |
| 3 | Cover (external interfaces) | 4 | Electrical inputs |
| 5 | Cursor keys | 6 | Function (soft) keys |
| 7 | Release valve (releases pressure through 8) | 8 | Vent port |
| 9 | Select positive or negative pressure | 10 | Pump |
| 11 | Fine pressure adjuster | | |

Figure 1-2: DPI 610/615 IS Calibrator Controls

1.10 Electrical Connections

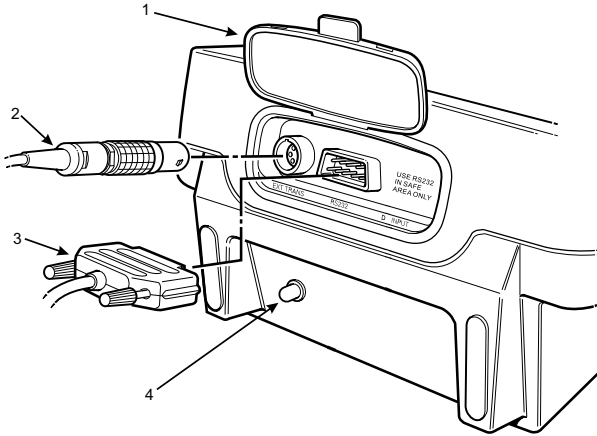

- | | | | |
|---|---|---|---------------------|
| 1 | Cover, closed when not using connectors | 2 | External transducer |
| 3 | RS232 connector | 4 | Temperature sensor |

Figure 1-3: Electrical System Connections

Measurement inputs and Source outputs are made via the control panel sockets as shown below:

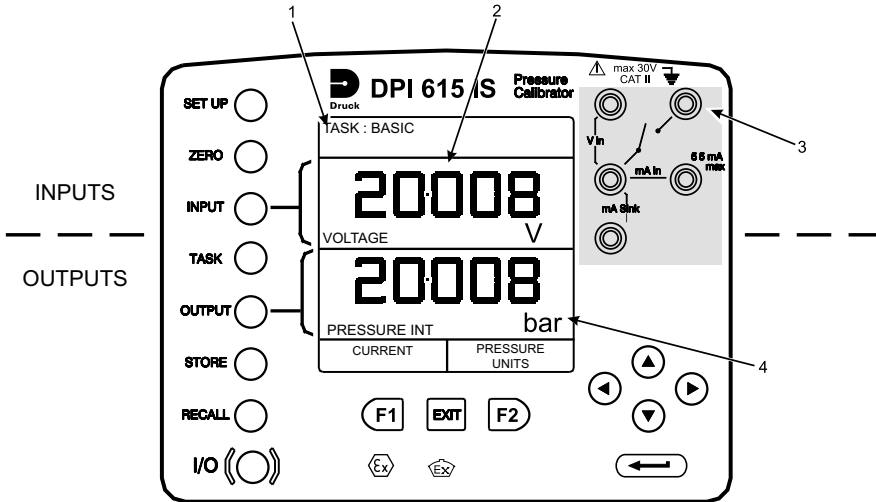

- | | | | |
|---|--------------------------------------|---|---------------|
| 1 | Status window | 2 | Input window |
| 3 | Electrical measurement input sockets | 4 | Output window |

Figure 1-4: Electrical Measurement Inputs/Source Outputs

2. Getting Started

2.1 Fitting Batteries

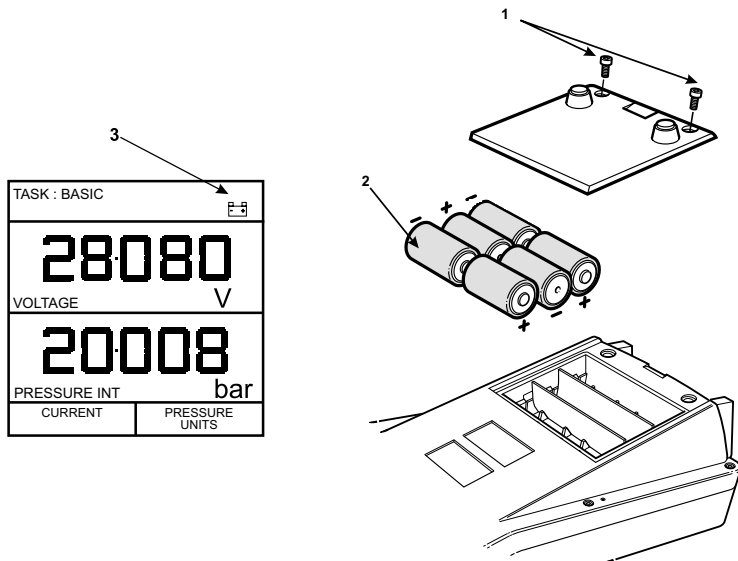

- 1 Cover fixing screws.
- 2 Six alkaline C cells, see table. Only use the battery type in the table.
- 3 Low battery indication.



WARNING Batteries must only be fitted in a safe area.
Use only the batteries specified in “Batteries” on page ii.



CAUTION Old batteries can leak and cause corrosion. Never leave discharged batteries in the instrument. Old batteries should be treated as hazardous waste and disposed of accordingly.

2.2 Switching On

Press the **I/O** switch on the front panel and proceed as follows:

The first time that the instrument is powered up, it will power-up in **BASIC** mode with the main screen displaying voltage in the input display area and pressure in the source display area. To switch to **Current** as input, press **F1** as shown. Similarly, **F1** to return to **Voltage**.

Note: No other keys are active in this mode and the instrument can only be reconfigured by pressing the **TASK** key and selecting another mode.

2.3 Change Pressure Units

To change the pressure units proceed as follows. If the four units displayed are not the units required, press **TASK** and select any task, other than **BASIC**, press **SETUP** and proceed as detailed in Section 7.1. To return to **BASIC** mode, press **TASK** and select **BASIC**.

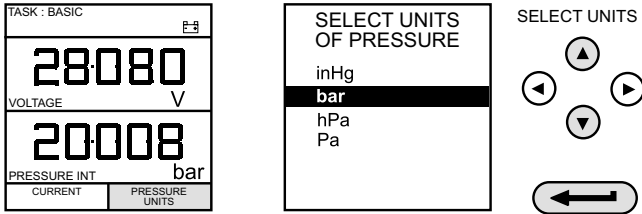

In **BASIC** mode, the unit is configured to carry out basic Pressure to Voltage (**P to V**) or Pressure to Current (**P to I**) tests, a typical test procedure follows:

2.4 Voltage and Current Measurements

Connect the electrical input sockets as follows for voltage and current measurements. Use the test leads provided and **DO NOT** push bare wires into the sockets.

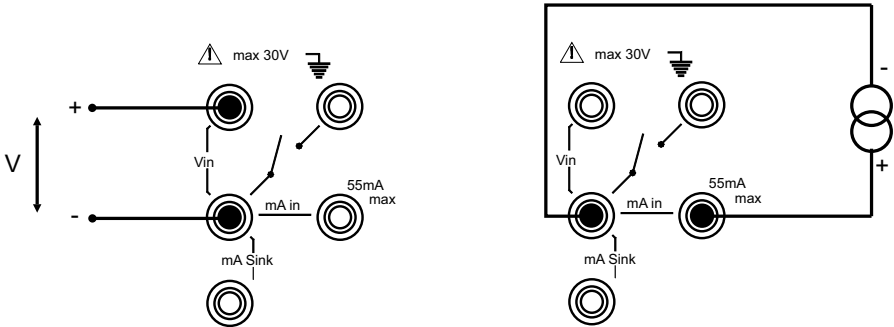

Note: See Table 1-2 on page 2 for maximum instrument ratings.

2.5 Typical Calibration Set-up (Pressure to Voltage)

Connect a device under test to the instrument as shown below:

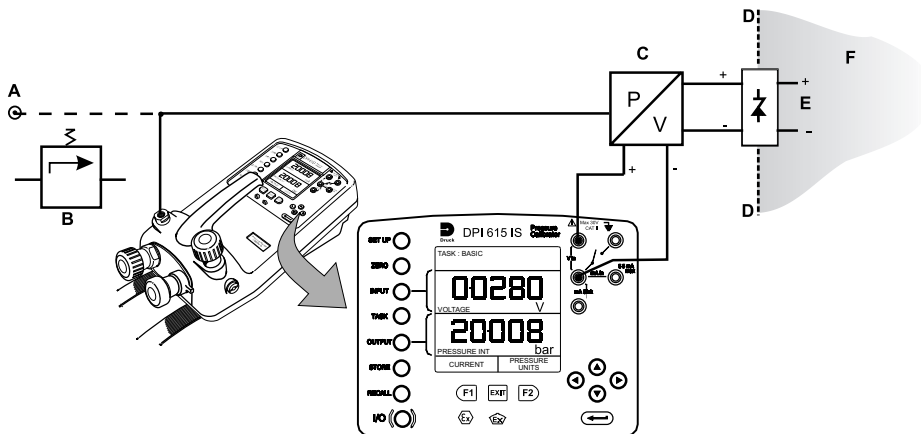

- | | | | |
|---|---|---|--------------------|
| A | External pressure source (indicator instruments only) | B | Pressure regulator |
| C | Pressure to voltage device | D | Barrier |
| E | Excitation 10 V | F | Safe area |

2.5.1 General Procedure

Use the hand-pump to pressurize the system to the required level as indicated on the display. Allow the display to settle and screw the volume adjuster in or out as a fine adjustment to the required pressure. Record the input: **Voltage**, reading at each applied pressure.

2.6 Zero Display Reading

Both the input and output readings can be set to zero by using the **ZERO** key and if the displayed reading is within 5% of zero. To zero either the **INPUT** or **OUTPUT** displays, proceed as follows:

3. Task Selection

3.1 Task Key

The TASK key is used to set-up the instrument for a number of specific types of test. There are two modes **BASIC** and **ADVANCED** and nine other specific types of test which automatically configure the instrument on selection from the **TASK** menu. The tasks available under the **TASK** menu are held on three pages shown below. To select a task from the menu, press the **TASK** key, position the cursor over the required task and press the **ENTER** key as shown below. Use the right/left cursor keys to switch between pages.

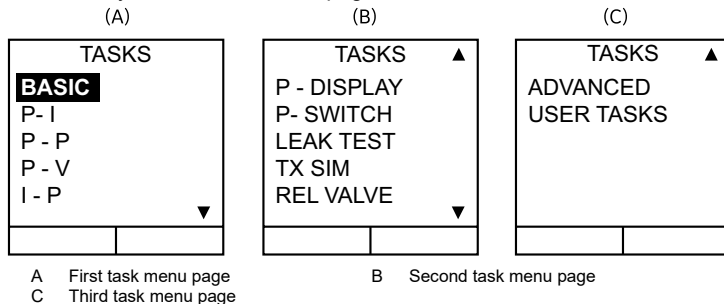

3.2 Using TASK Functions

Specific tasks are selected as shown above. The following diagrams show how to connect the unit under test (UUT) for each task selectable under the **TASK** menu.

Input and output units, where applicable, can be selected by pressing either the **INPUT** or **OUTPUT** keys as shown below.

3.3 Set Units

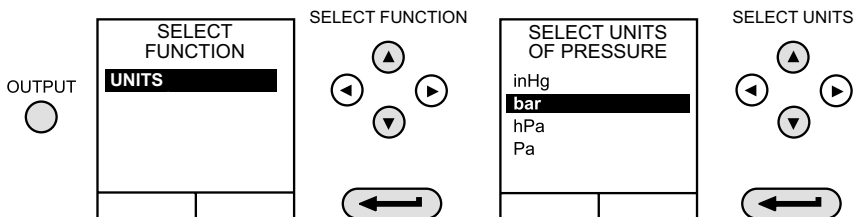

Note: If the four units displayed are not the units required, press **SETUP**, select **SETTINGS** and refer to select regular units in Section 7.4.1.

3.4 Cal Mode (DPI 615 versions only)

Cal mode, which is available in tasks P-I, P-P, P-V, P-P, P-DISPLAY and P-SWITCH, provides a method of setting up test parameters manually. Downloaded test procedures can also automatically set up and turn on the Cal Mode function. The method of turning on and setting up Cal Mode is shown below for a P-I task. A similar method can be used for all the other tasks applicable to the Cal Mode function.

Pressing the **F1** key (TURN ON CAL MODE), provides the set-up screen for the CAL mode. Initially, the cursor is placed in the UUT SPAN field to allow the required span range to be entered. The corresponding values for the UUT output parameter (current) are then set, followed by the maximum error value and error type (%rdg or % span). When all test parameters have been set-up, the screen changes to display the input and output and the test results. The test result can

Chapter 3. Task Selection

only be displayed to within a range of $\pm 9.99\%$. If the test result is outside this range, either the left pointing (-ve error) or right pointing (+ve error) chevrons are displayed. Within this error band, the actual tolerance value is displayed. Test results can either be stored as snapshots or logged as data log files, depending on how the instrument has been set-up.

3.5 Basic Mode (Task BASIC)

This instrument will power-up in this mode the first time that it is used. To select **BASIC** from any other task, press the **TASK** key and select **BASIC** and press the **ENTER** key. **BASIC** mode is described in Section 2.2.

4. Taking Measurements

4.1 Pressure Transmitter (P-I) Task

Select the P-I task from the task menu and connect the Unit Under Test (UUT) to the calibrator as shown below:

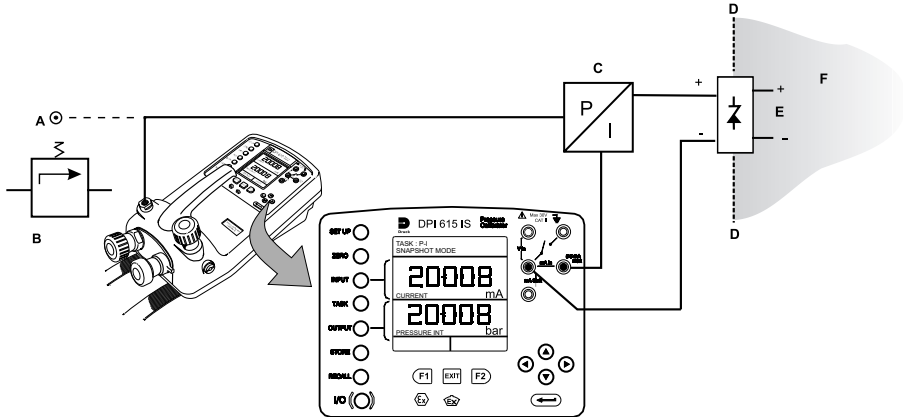

- | | | | |
|---|---|---|--------------------|
| A | External pressure source (indicator instruments only) | B | Pressure regulator |
| C | Pressure to current device | D | Barrier |
| E | External supply | F | Safe area |

- If required, select the output units as described in Section 3.3.
- If applicable, turn on Cal Mode and set-up test parameters as detailed in Section 3.4.

4.2 Voltage Output Pressure Transmitter (P-V) Task

Select the P-V task from the task menu and connect the Unit Under Test (UUT) to the instrument as shown below:

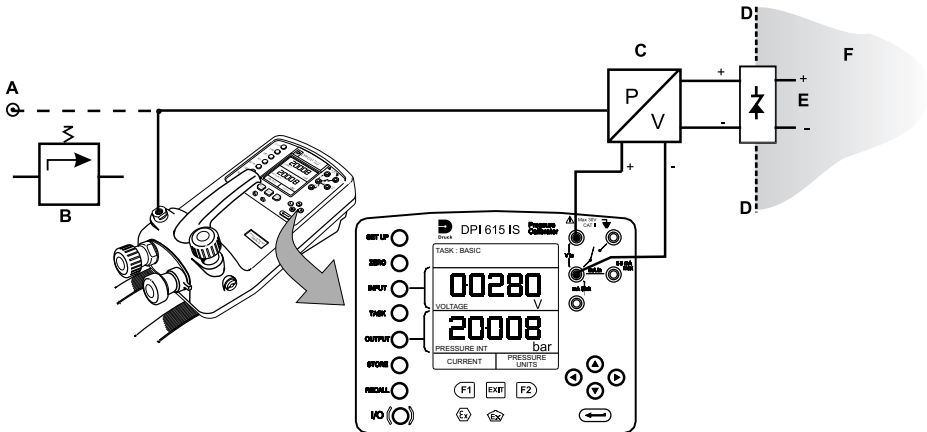

- | | | | |
|---|---|---|--------------------|
| A | External pressure source (indicator instruments only) | B | Pressure regulator |
| C | Pressure to voltage device | D | Barrier |
| E | External supply | F | Safe area |

- If required, select the output units as described in Section 3.3.

Chapter 4. Taking Measurements

- If applicable, turn on Cal Mode and set-up test parameters as detailed in Section 3.4.

4.3 Pressure Converter (Pressure to Pressure) Task

Select the P-P task from the task menu and connect the Unit Under Test (UUT) to the calibrator as shown below. Testing a converter requires one pressure to be applied to the unit under test (UUT) and another (converter output) to be measured. The additional measurement is provided by the external transducer option.

- Connect the UUT to the instrument as shown below. Plug the external transducer into the instrument as shown below:

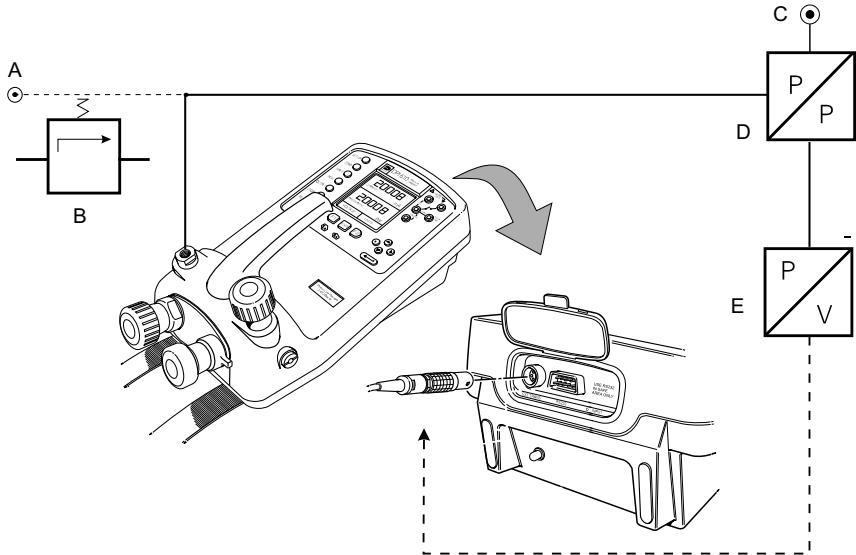

- | | | | |
|---|---|---|-----------------------------|
| A | External pressure source (indicator instruments only) | B | Pressure regulator |
| C | External pressure source | D | Pressure to pressure device |
| E | External supply | | |

- Press the **TASK** key and select the P-P task. Providing the external transducer has been calibrated and its parameters stored in the instrument, the display will show **External** pressure in the input window and calibrator **Output** pressure in the output window. If an error message “NO SENSOR OR CAL INVALID” is displayed, this indicates that the external transducer has not been entered and/or calibrated with the instrument. Refer to Section 8.16 for details of adding an external transducer.

Note: If an external transducer change is made, switch the calibrator off and then on to load new transducer data.

- If required, select the output units as described in Section 3.3.
- If applicable, turn on Cal Mode and set-up test parameters as detailed in Section 3.4.

4.4 Current to Pressure Converter (I-P) Task

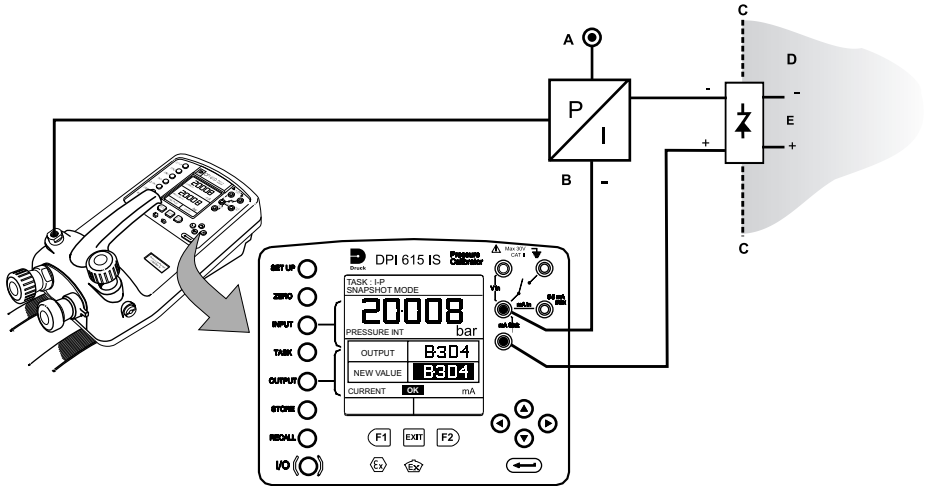

- | | | | |
|---|--------------------------|---|-----------------------------------|
| A | External pressure source | B | Pressure to current device (24 V) |
| C | Barrier | D | Safe area |
| E | External supply | | |

- Use the **up ▲** and **down ▼** cursor keys to adjust the loop current to the required value. Alternatively, press **ENTER** and use cursor keys to enter a finite value. Cursor keys can then be used to nudge the output either up or down.
- If required, change pressure units with **INPUT** key. A flashing **CHECK LOOP** message indicates either an open circuit supply loop (or no external supply).

4.5 Pressure Switch Test (P-SWITCH) Task

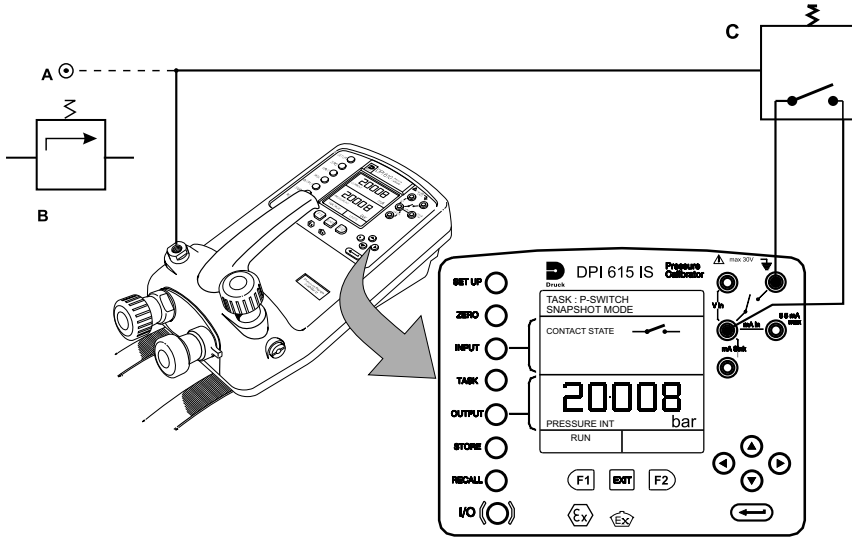

A External pressure source
C Pressure switch under test

B Pressure regulator

- Contact state will be shown on display. When contacts close, buzzer sounds.
- To run switch test, close vent valve and press the **RUN** (F1) key.
- Using the hand-pump, increase the applied pressure to just below the switch operating point. Screw the volume adjuster in until the switch operates (the operating pressure of the switch is then written to the display).
- Reduce pressure until the switch releases (indicated by the switch symbol). The release pressure is then written to the display and the hysteresis displayed.

4.6 Pressure to Display (P-DISPLAY) Task

P-Display is a special application of Data Log. To use this mode, select Data Log from the Store Mode menu as detailed in Section 7.2. Connect the UUT to the instrument as shown below and, if required, turn on and set-up Cal Mode (see Section 3.4).

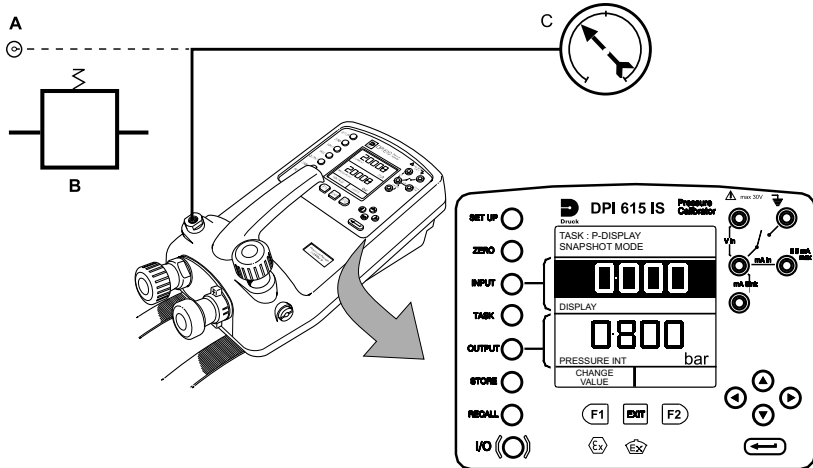

A External pressure source
C Dial gauge under test

B Pressure regulator

- Press **TASK** and select **P-DISPLAY**. If required, use **OUTPUT** key to change pressure units.
- Set-up a data log file as detailed in Section 6.4.

Note: **TRIGGER** field, automatically set to **KEYPRESS**, cannot be changed.

- Apply a series of test pressures to the device under test. Enter displayed leading at each pressure and log each point:
- After logging final test point, terminate as follows:

4.7 Leak Test (LEAK TEST) Task

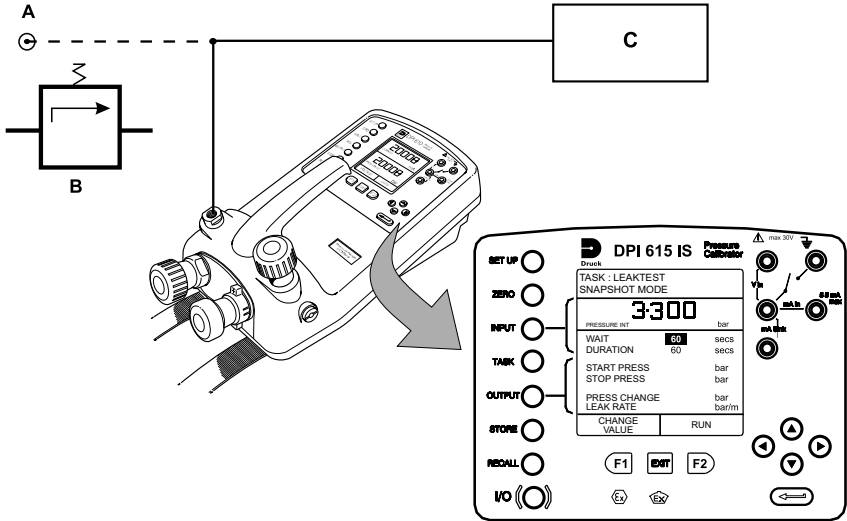

A External pressure source
 B Pressure regulator
 C Device/system under test

- If required, use the **INPUT** key to change pressure units.
- Set-up the leak test **WAIT** and **DURATION** times to the required values as shown below. A minimum wait period of 3 minutes is recommended.

TASK: ADVANCED SNAPSHOT MODE	
0:304 bar	
WAIT	180 secs
DURATION	60 secs
START PRESS	bar
STOP PRESS	bar
PRESS CHANGE	bar
LEAK RATE	bar/m
CHANGE VALUE	RUN

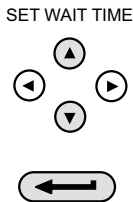

TASK: ADVANCED SNAPSHOT MODE	
0:304 bar	
WAIT	180 secs
DURATION	60 secs
START PRESS	bar
STOP PRESS	bar
PRESS CHANGE	bar
LEAK RATE	bar/m
CHANGE VALUE	RUN

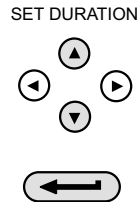

- Close the vent valve and pressurize the device/system to the required **LEAK TEST** pressure.
- Press the **RUN (F2)** key to start the leak test. When completed, the beeper sounds and the leak test results are written to the display.

4.8 Transmitter Simulator (TX SIM) Task

When used with an external voltage source (see Section 5.6), provides a current output proportional to the calibrator's measured output pressure (indicated pressure on indicator only version). Select task **Tx SIM**. Press **EXIT** to skip set-up screen if parameters are correct.

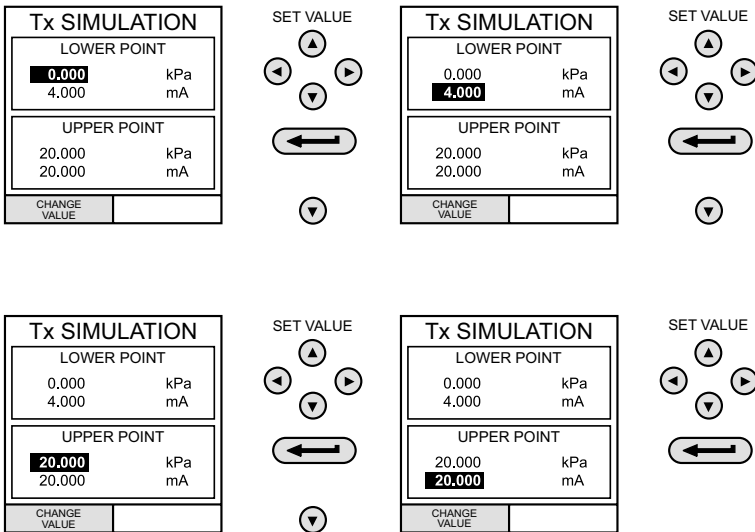

On completion of **Tx SIM** set-up, the display is configured as follows:

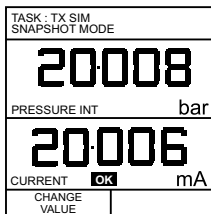

Connect an external power source to the output loop as detailed in Section 5.6.

To subsequently change any of the **Tx SIM** scaling parameters, press **CHANGE VALUE** key (F1) to obtain the TX Simulation set-up display.

To change the pressure units, press **INPUT** and select the required scale units. If the required scale units are not listed, press **SETUP**, select **SETTINGS** and proceed as detailed in Section 7.4.1.

4.9 Relief Valve Test (REL VALVE) Task

To carry out a relief valve test, press **TASK** and select **REL VALVE**. Connect the output pressure port of the instrument to an external system as shown below:

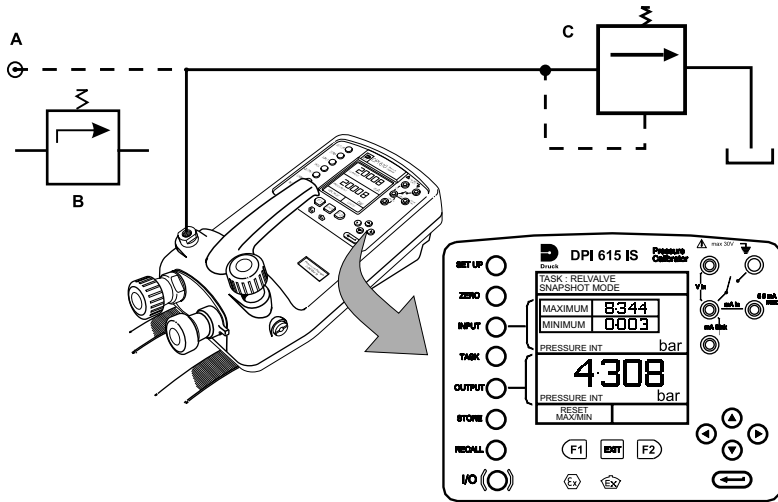

A External pressure source (indicator only) B Pressure regulator
C Relief valve under test

- To change the pressure units, if required, press **INPUT** and select the required units using the cursor keys.
- Close the vent valve and, using the hand-pump or external pressure supply, apply pressure to the relief valve under test.
- When the relief valve operates, the maximum recorded pressure indicates the operating point of the valve.
- Record the test results.

Note: The **STORE** key can be used for this purpose. Use right cursor key initially, followed by up/down keys to enter Snapshot text.

- Open vent valve to release test pressure.

Note: If using external pressure supply, isolate supply before opening the vent valve.

5. Advanced Task

5.1 General

Advanced task allows the user to configure the instrument to monitor one of a number of different input measurements and outputs (sources). Additionally, five process functions, **Tare**, **Max/Min**, **Filter**, **Flow** and **%Span** can be applied to the input functions.

5.2 Select Input

To select an input channel, select **ADVANCED** task from the task menu. The display shows the list of the input selections and, if available, the **PROCESS** soft box (F1) and the **UNITS** soft box (F2).

The following procedure shows the method of input channel selection and the method of changing units:

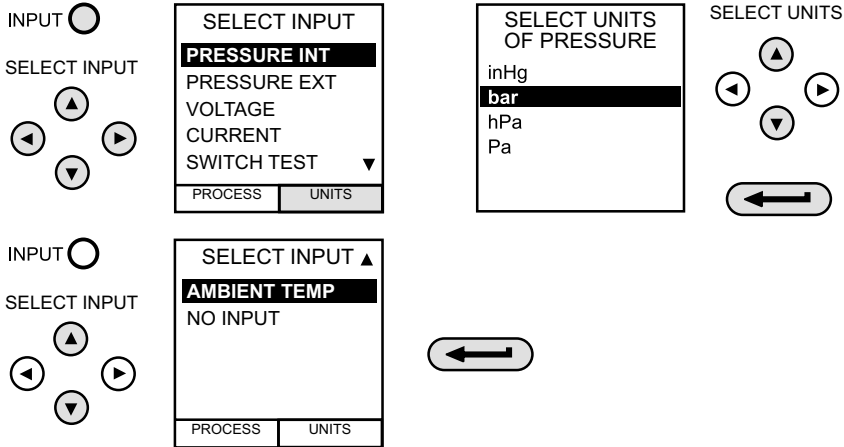

Note: Left/right arrow keys function as page up/down keys.

Refer to Section 5.4 for details of process functions.

5.3 Ambient Temperature Measurement

To set-up the instrument to read ambient temperature, proceed as follows:

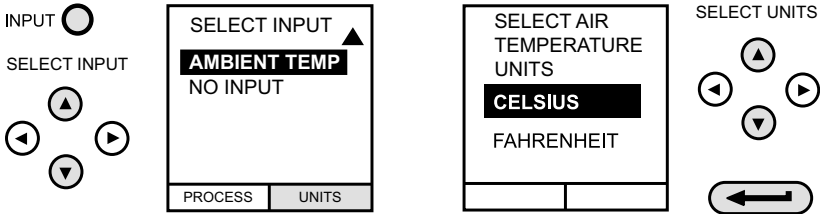

Note: Ensure that the temperature reading has stabilized.

5.4 Process Functions

If required, the following process functions are available on the input display but only in **ADVANCED** task. If the instrument is in any other mode i.e. **BASIC** or any other task mode, the input and output displays must first be configured in **ADVANCED** task.

Chapter 5. Advanced Task

Note: **PROCESS** functions are not available to the output channel.

A summary of the process functions follows:

Table 5-1: Process Functions

Process	Description
Tare	Allows either the current display value or a manually entered value to be tared off display parameter reading.
Max/Min	Displays running Max/Min and present display values simultaneously. Resettable via F1 key.
Filter	Applies low pass filter function to displayed parameter. Filter characteristics "Settling time and Band" are user programmable.
Flow	Applies square root function to displayed parameter.
% Span	Converts displayed parameter reading to a percentage of span. Span definable via the F1 key.

Following selection of **ADVANCED** from the task menu, press the **INPUT** key. Use the **up ▲** or **down ▼** cursor keys to select the required input. Press the **PROCESS** (F1) key and use the **left ◀** or **right ▶** cursor keys to enable the process on/off:

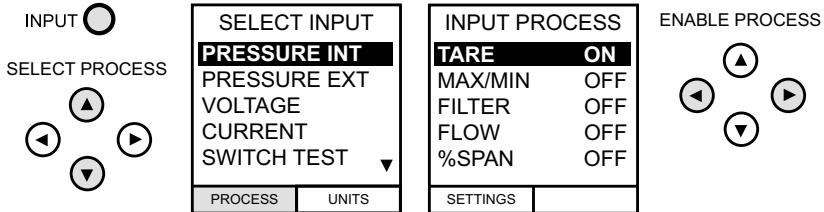

Press **ENTER** to switch the process ON with existing settings or F1 to change process settings (where applicable).

5.4.1 Tare Process Function

To set-up a Tare function, enable **TARE** from the process menu and press F1 to enter the Tare **SETTINGS** functions.

Disable **TARE** by entering process menu and turning the function **OFF**.

Note: Last **TARE** setting is retained and will be applied when function is next enabled.

5.4.1.1 Tare Current input Reading

To tare-off the current display reading, proceed as follows:

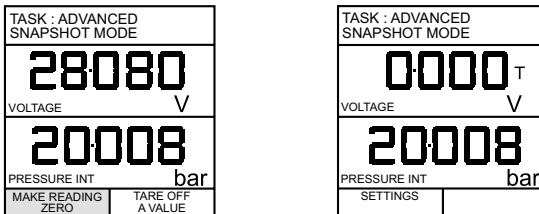

5.4.1.2 Tare Off An Entered Value

To tare-off an entered value current, proceed as follows:

Note: Display shows the last entered Tare Value.

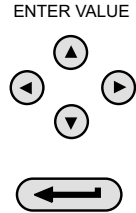
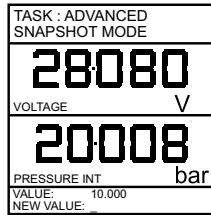
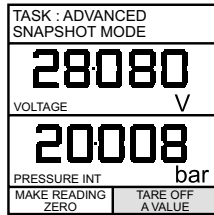

5.4.2 Min/Max Process Function

To set-up an input display to show min/max and present input reading, enable MIN/MAX from the process menu and press F1 (SETTINGS) to provide **RESET** function. The display now shows the max/min values as follows:

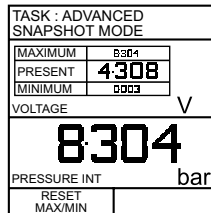

Reset Max/Min display at any time by pressing the F1 key.

To quit max/min, press **INPUT**, select **MAX/MIN** from process menu and switch the function off.

5.4.3 Filter Process Function

To apply the low pass filter to a selected input, enable **FILTER** from the process menu and press F1 (SETTINGS) to provide access to the filter parameters. Two settings are required, Time to Settle and Band.

To examine the current filter settings and exit without change, press the **EXIT** key.

The set-up procedure is as follows:

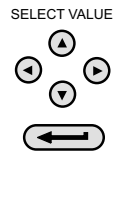
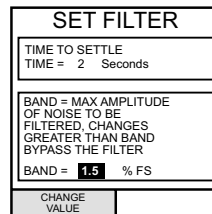
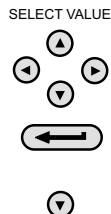
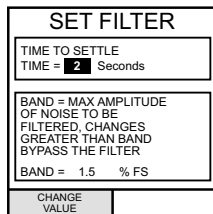

5.4.4 Flow Process Function

To apply the flow function to a selected input, enable FLOW from the process menu and press **ENTER**. The square root symbol is displayed beside the input value to indicate that the **FLOW** function is active:

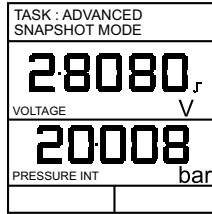

To cancel **FLOW**, press **INPUT** and turn function OFF at the process menu.

5.4.5 % Span Process Function

To convert a selected input display from a numerical value to a percentage of full-scale reading, enable **SPAN** from the process menu and press F1 (SETTINGS) to provide access to the span definition parameters. Two span definitions are required, **Zero** and **Full Scale**.

To leave span at current setting, press **EXIT**.

To define zero and full-scale settings, proceed as follows.

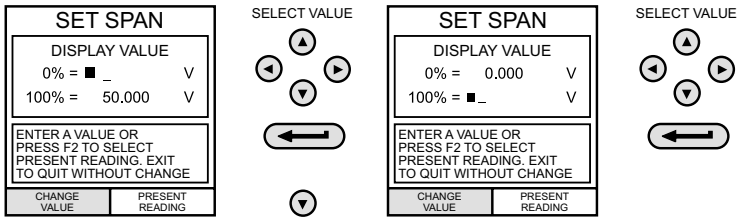

To cancel **%SPAN**, press **INPUT** and turn function OFF at the process menu.

5.5 Select Output

To display an output channel, select **ADVANCED** mode from the task menu. The display shows the list of output selections and, if available, the **UNITS** soft box (F2).

The following procedure shows the method of output channel selection from two pages of options. The second page can be obtained directly from the first by pressing the **right** ► cursor key:

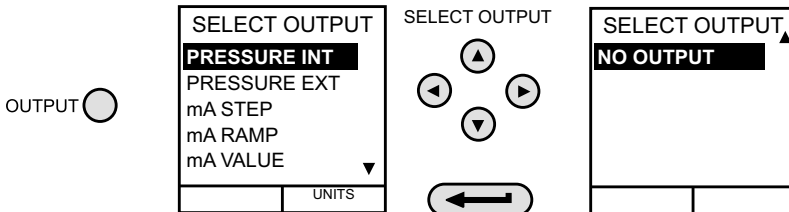

Note: Left/right arrow keys function as page up/down keys.

To change the output units (*pressure* channels only), select the channel with the cursor keys and press F2 before pressing **ENTER**.

5.6 Electrical Outputs (Loop Power)

All the electrical outputs, the output loop must be powered from an external supply (current sinking).

External connections to the front panel of the instrument are shown below.

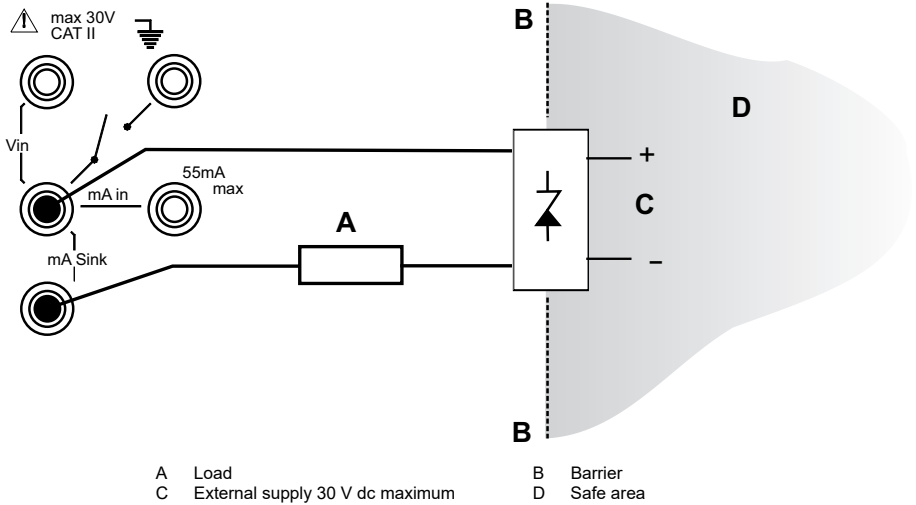
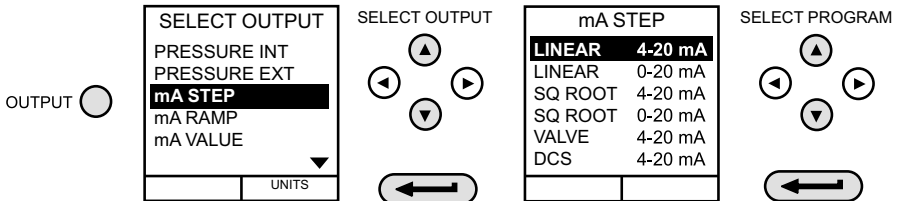

Figure 5-1: Current Sinking

5.6.1 mA Step

To select one of the electrical output programs, press the **OUTPUT** key and proceed as follows:



On selection of (e.g.) Linear, the output display window changes to show the selected program of output currents:

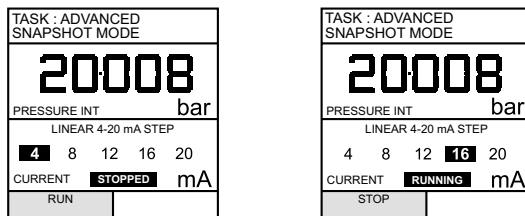

- Connect an external power source as shown in Section 5.6.
- Press **RUN** (F1) to run program. A flashing status display **CHECK LOOP** indicates a fault in the external loop i.e. supply fault or open circuit.

Note: The dwell time at each step is approximately 10 seconds.

Chapter 5. Advanced Task

- Press **STOP** (F1) when running to stop at any point. Press **RUN** (F1) to resume.

5.6.2 mA Ramp

Press the **OUTPUT** key and select **mA Ramp** as shown previously in mA Step.

- Define ramp required by entering **START** and **END** current values as shown below:

TASK : ADVANCED SNAPSHOT MODE	
8:304 bar	
PRESSURE INT	
START	4000
OUTPUT	0000
END	20000
CURRENT	STOPPED mA
START	

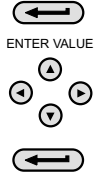

TASK : ADVANCED SNAPSHOT MODE	
8:304 bar	
PRESSURE INT	
START	4000
OUTPUT	8334
END	20000
CURRENT	STOPPED mA
START	



- Connect an external power source as shown in Section 5.6.
- Press **START** (F1) to run the program. A status display **CHECK LOOP** indicates a fault in the external loop i.e. supply fault or open circuit.

Note: The ramp cycle (min to max or max to min), is approximately 60 seconds.

TASK : ADVANCED SNAPSHOT MODE	
8:304 bar	
PRESSURE INT	
START	4000
OUTPUT	0000
END	20000
CURRENT	STOPPED mA
START	

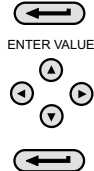

TASK : ADVANCED SNAPSHOT MODE	
8:304 bar	
PRESSURE INT	
START	4000
OUTPUT	8334
END	20000
CURRENT	RAMPING mA
STOP	



- Press **STOP** (F1) when running to stop at any point. Press **CONTINUE** (F1) to resume from point of pause or **RESET** (F2) to return to start point.

TASK : ADVANCED SNAPSHOT MODE	
8:304 bar	
PRESSURE INT	
START	4000
OUTPUT	0000
END	20000
CURRENT	STOPPED mA
STOP	

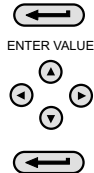

TASK : ADVANCED SNAPSHOT MODE	
8:304 bar	
PRESSURE INT	
START	4000
OUTPUT	8334
END	20000
CURRENT	PAUSED mA
CONTINUE	RESET

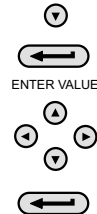

5.6.3 mA Value

Press the **OUTPUT** key and select **mA Value** from the output menu. The procedure is shown below:

SELECT OUTPUT	
PRESSURE INT	
PRESSURE EXT	
mA STEP	
mA RAMP	
mA VALUE	

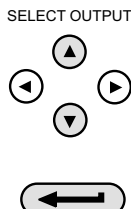

TASK : ADVANCED SNAPSHOT MODE	
20008 bar	
PRESSURE INT	
OUTPUT	0000
NEW VALUE	0000
CURRENT	OK mA

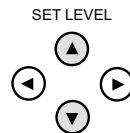

- Connect an external power source as shown in Section 5.6.

- Use **up ▲** and **down ▼** cursor keys to adjust output current level. While the loop is made, a status display indicates **OK**. A status display **CHECK LOOP** indicates a fault in the external loop i.e. supply fault or open circuit.

5.7 Define New Task

To define a new task, proceed as follows.

- Select **ADVANCED** from **TASK** menu.
- Using the **INPUT** key, select the required input for the input display and set-up any process functions required.
- Using the **OUTPUT** key, select the required output for the output display.
- Press **TASK** and select **free**. Enter new task name as follows:

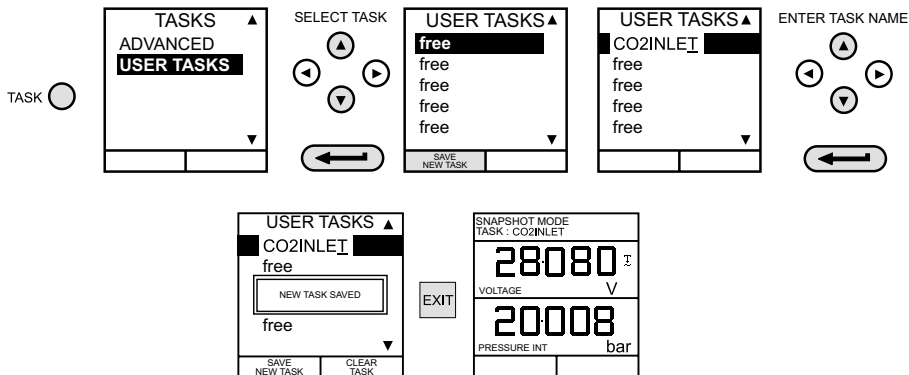

On completion of the this procedure, the display reverts to newly set-up task as shown.

5.8 Clear Task

To clear a user defined task, select **TASK** and proceed as follows:

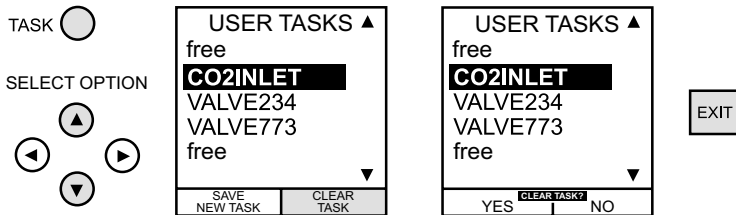

6. Memory Operations

6.1 Saving Display or Data Log

In Store Mode three memory operations can be set-up: **None**, **Snapshot** and **Datalog**. Refer to Section 7.2 for details.

6.2 Store Operations (Screen Snapshots)

To store any display (menu displays excepted), press the **STORE** key. This saves the current display to the next available location. Supporting text (10 characters) may be appended. Twenty memory locations are available on a cyclic buffer. When all 20 have been used, store operations overwrite existing locations, starting at Location 1.

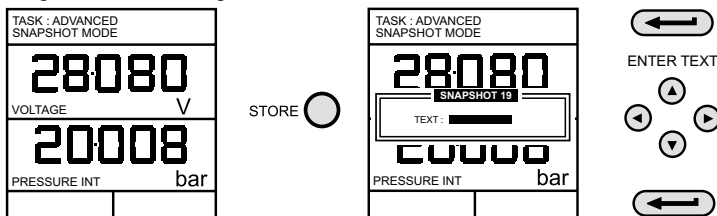

6.3 Recalling Stored Data (Screen Snapshots)

To recall a previously stored display, press the **RECALL** key. This recalls the last display saved. Press the **left** ◀ or **right** ▶ cursor keys to recall the previous or next locations respectively. To exit **RECALL**, press the **EXIT** key.

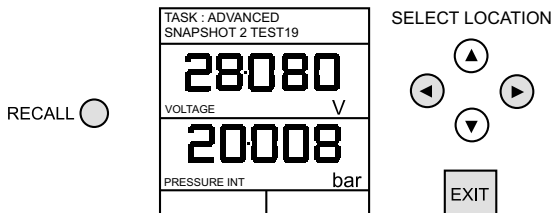

6.4 Data Log Operations

Data Log is a special application of store mode which enables the calibrator to either automatically log displays at preset time intervals or to manually log a display on operation of the **STORE** key. Logged data is written to a user specified file.

To set-up a Data Log file, proceed as follows.

- Select a task, other than **BASIC**. If using **ADVANCED**, set-up the required output parameters.
- Use **SETUP** to select Data Log from the Store Mode Menu (See Section 7.2).

Chapter 6. Memory Operations

6.4.1 Auto Log (Timer)

Press **STORE** and set-up the Data Log file parameters as shown below. Use **CHANGE VALUE** (F1) followed by cursor keys to set field values. For Auto Log, set-up **TRIGGER** field to **PERIODIC**.

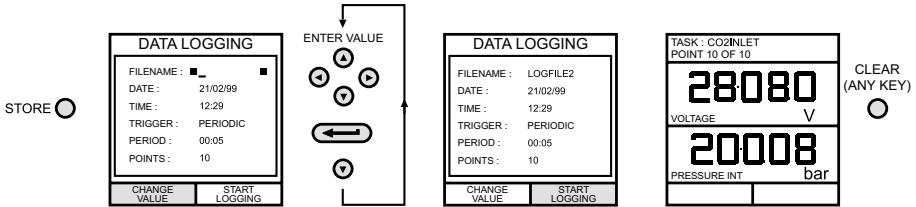

6.4.2 Manual Logging

Enter the file details as shown above and select **KEYPRESS** for **TRIGGER** field. Screen reverts to displayed parameters showing set-up file as shown below:

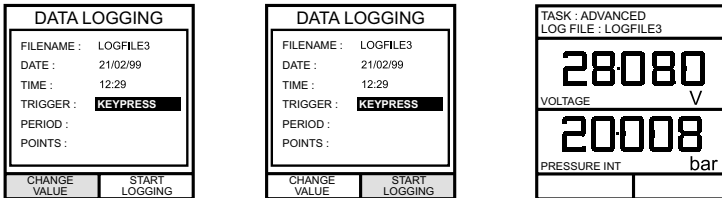

- Use a combination of **STORE** and **LOG NOW** (F1) to log events as follows:

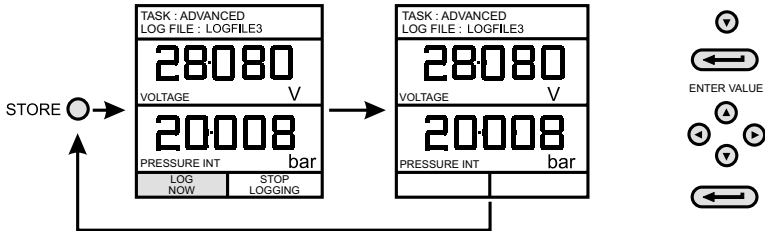

6.4.3 Recall Data Log Files

To recall a Data Log file to the display, ensure that **DATA LOG** is selected from the **SETUP** menu and proceed as follows:

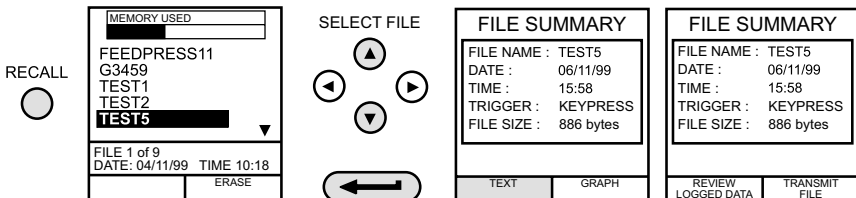

Data Log files can be displayed either as text (stored screens) or in graphical form. To display as text, proceed as follows from the File Summary menu. Select Auto Step to automatically review each screen at 1 second intervals or use the **left** ◀ and **right** ▶ cursor keys to manually review.

FILE SUMMARY	
FILE NAME :	TEST5
DATE :	06/11/99
TIME :	15:58
TRIGGER :	KEYPRESS
FILE SIZE :	886 bytes
REVIEW LOGGED DATA	TRANSMIT FILE

TASK : P-1 DATALOG	
18882	
mA	
<<< %span FAIL	
20008	
bar	
AUTO STEP	DATA POINT 1 OF 11

MANUAL REVIEW

To display logged data in graphical form, on screen, proceed as follows from the File Summary menu:

FILE SUMMARY	
FILE NAME :	TEST5
DATE :	06/11/99
TIME :	15:58
TRIGGER :	KEYPRESS
FILE SIZE :	886 bytes
TEXT	GRAPH

TEST5	
mA v t	
bar v t	
mA v bar	
Error v bar	

SELECT GRAPH AXES

TEST5	
20.007	
TIME	
3.902	
15:08:55	
16:18:23	

6.4.4 Uploading Data Log Files



WARNING The RS 232 interface must only be used in a safe area.

Connect the RS 232 socket of the instrument into either the COM1 or COM2 port of the PC. Ensure that the RS 232 parameters set in the PC match those of the instrument. The RS 232 parameters of the instrument can be checked as detailed in Section 7.4.4. Set up a file on the PC to receive the data, (e.g.) in the *Windows® HyperTerminal* program.

To upload a file, proceed as follows. Appendix 1 gives details of a typical uploaded data log file.

RECALL

MEMORY USED
FEEDPRESS11
G3459
TEST1
TEST2
TEST5
FILE 1 of 9
DATE: 04/11/99 TIME 10:18
ERASE

SELECT FILE

FILE SUMMARY	
FILE NAME :	TEST5
DATE :	06/11/99
TIME :	15:58
TRIGGER :	KEYPRESS
FILE SIZE :	886 bytes
TEXT	GRAPH

FILE SUMMARY	
FILE NAME :	TEST5
DATE :	06/11/99
TIME :	15:58
TRIGGER :	KEYPRESS
FILE SIZE :	886 bytes
REVIEW LOGGED DATA	TRANSMIT FILE

Chapter 6. Memory Operations

6.4.5 Delete Datalog and Procedure Files

To delete a Data Log file, or a procedure file (DPI 615 instruments only), proceed as follows. Alternatively, to delete all logged files simultaneously, select **ERASE ALL FILES** (F2) at the erase screen.

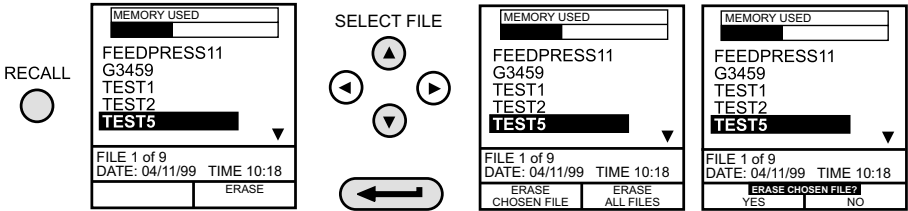

6.4.6 Downloading Procedure Files



WARNING The RS232 interface must only be used in a safe area.

Complete test procedures may be downloaded from a PC to the instrument (DPI 615 instruments only) via the RS232 port. A procedure consists of a number of Druck Universal Command Interface (DUCI) commands that are usually assembled by a linking management software application (e.g. **4Sight™ 2**).

Before downloading a procedure, the instrument must be in the REMOTE mode. To place the instrument into REMOTE mode, proceed as follows.

- Connect the instrument's RS232 port to a free COM port on a PC.
- Make sure that the COMMS parameters of the PC match those of the instrument (refer to Section 7.4.4).
- Make sure that the instrument is not already running a procedure. If it is, quit the procedure.
- Download the procedure. Procedures are stored in the Data Log directory.

The following sequence shows a typical download sequence that starts with the instrument in LOCAL mode.

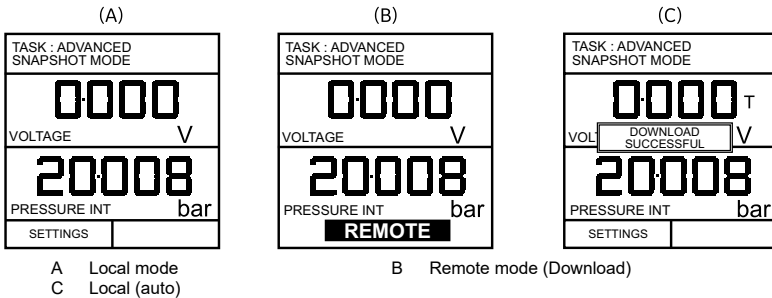

After the procedure file has been downloaded, the instrument is usually returned to the LOCAL mode by the last command in the procedure file. If the instrument remains in REMOTE mode, switch it OFF and ON to reset it.

6.4.7 Running Procedure Files

To run a procedure (DPI 615 instruments only), make sure that the instrument is set to Store mode, Data Log (see Section 7.2), and proceed as follows:

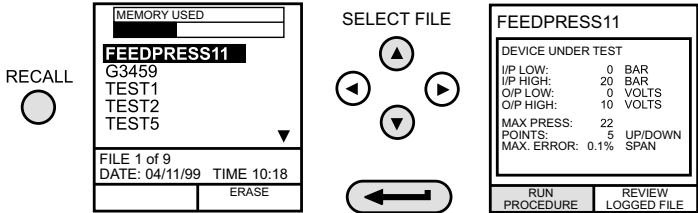

After selecting F1, proceed by entering the User ID and Serial Number and then select F1 (Continue) and follow the on-screen procedural instructions:

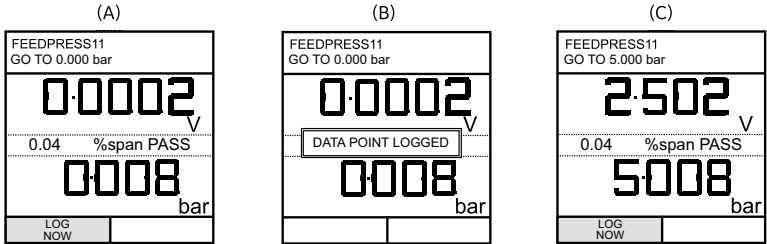

- A Setup and Log Point 1
- B Point 1 stored
- C Setup and Log Point 2 etc.

When the test procedure for a given UUT has been completed, the result of running the first test is stored as an AS FOUND file. This file cannot be overwritten. Any subsequent tests on the device are stored as an AS LEFT file that is overwritten each time the procedure on this device is run.

When recalling the results of a procedure, the choice of AS FOUND or AS LEFT is provided (refer to Section 6.4.8).

6.4.8 Recalling Data Files

Data or results files generated by running procedures (DPI 615 instruments only) are stored in the instrument's data log directory. To recall a data file to the display, make sure that **DATA LOG** is selected from the **SETUP** menu and proceed as follows:

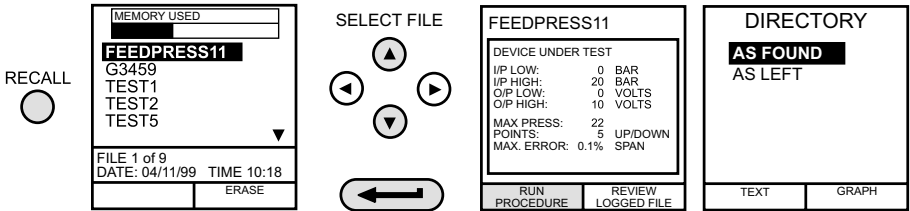

Use the cursor keys to select either the AS FOUND option or the AS LEFT option for display. AS FOUND is the result of the first run of a procedure and AS LEFT is the result of the last time the procedure was run.

Procedure data files can be displayed either as text (stored screens) or in graphical form. To display as text, select the **TEXT** option (F1) from the directory and proceed as follows from the

Chapter 6. Memory Operations

File Summary menu. Select **AUTO STEP** (F1) to automatically review each screen at 1 second intervals or use the **left** ◀ or **right** ▶ cursor keys to manually review.

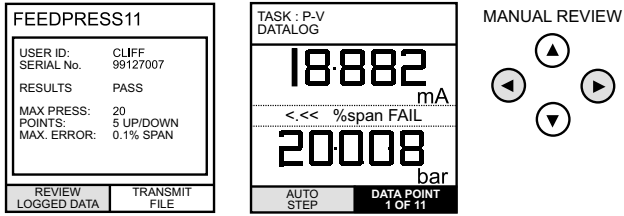

To transmit the selected logged data via the RS232 interface, connect the instrument to a free COM port on a compatible PC, ensure that the instrument's RS232 parameters match those of the PC.

To display logged data in graphical form, on screen, select **GRAPH** (F2) from the directory and proceed as follows:

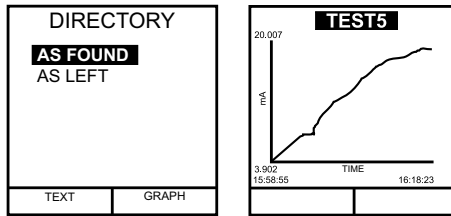

7. Using Set-up

7.1 General

SETUP mode is available in all modes except **BASIC** and permits the changing of the following instrument parameters.

- Store Mode - None, Snapshot, Data Log.
- Contrast.
- Settings - Units, Language, RS232 parameters, Powerdown and Calibration Routines (Refer to Section 8 for calibration details).
- Date and Time (Real Time Clock).

7.2 Store Mode

Select **STORE MODE** from the Set-up menu and select required mode as follows:

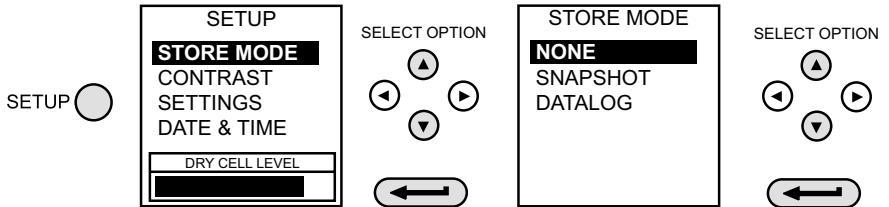

7.3 Contrast

Select **CONTRAST** from the Set-up menu and proceed as follows:

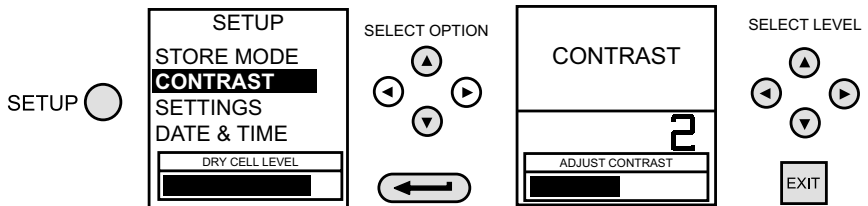

7.4 Settings - Select Setup Option

To select one of the **SETTINGS** options from the set-up menu, proceed as follows:

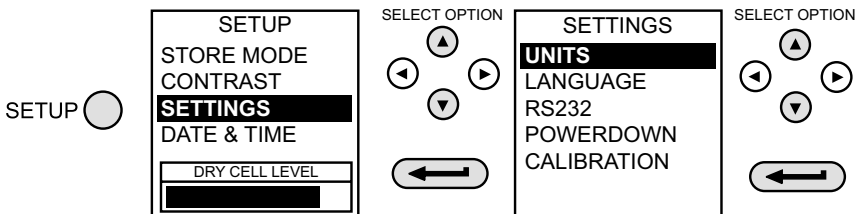

Chapter 7. Using Set-up

7.4.1 Units

Select **UNITS** from the **SETTINGS** menu and proceed as follows:

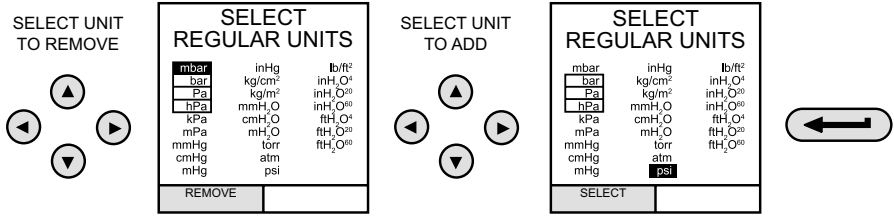

7.4.2 Define Special Units

Select **UNITS** from the **SETTINGS** menu and select **SPECIAL UNITS** and proceed as follows:

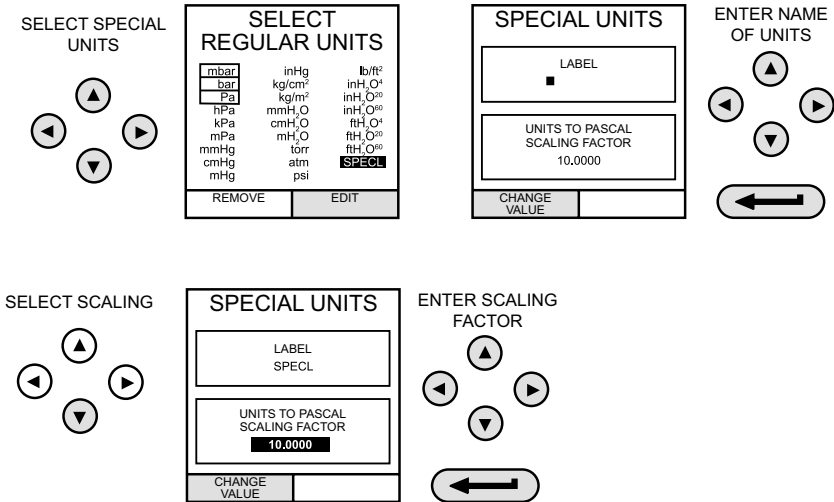

7.4.3 Language

Select the **LANGUAGE** version required from the **SETTINGS** menu and proceed as follows:

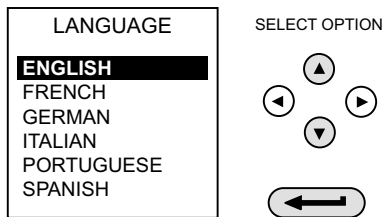

7.4.4 RS232

Select **RS232** from the **SETTINGS** menu and proceed as follows:

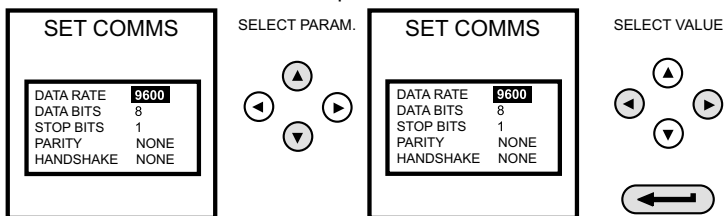

Note: Default settings are shown above. If a communications problem occurs at a particular baud rate, change the baud rate on the instrument and the PC to a lower rate.

7.4.5 Powerdown

Select **POWERDOWN** from the **SETTINGS** menu and proceed as follows:

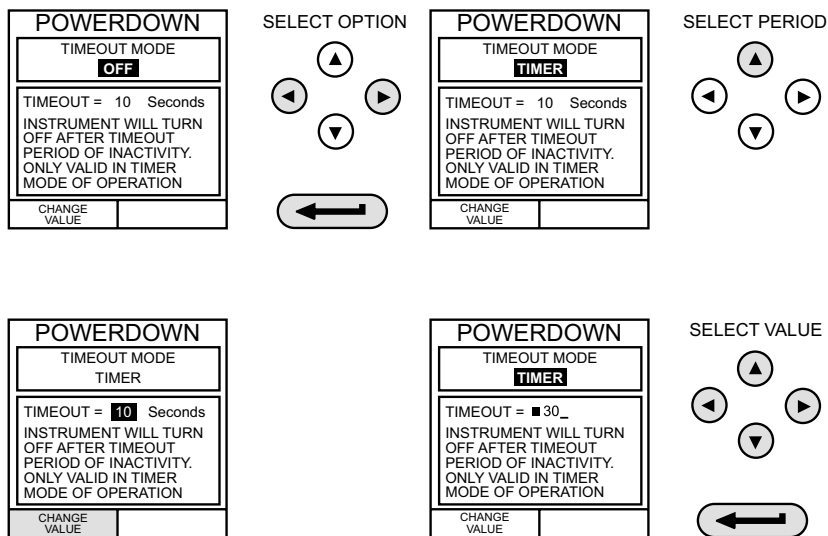

If selected to **TIMER** mode, following a period of inactivity, the instrument automatically powers off after the preset **TIMER** period.

If selected **OFF**, auto power off is inhibited and once switched on, the instrument remains **ON** until it is manually switched **OFF**.

7.4.6 Calibration

Refer to Section 8 for a full description of the calibration procedures.

7.5 Date and Time (Real Time Clock)

7.5.1 Date Format

To set-up the real time clock, select **DATE & TIME** from the set-up menu and, using the **right ►** key, set the required date format:

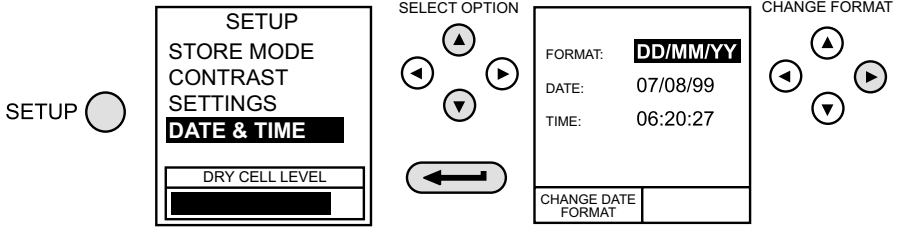

7.5.2 Set Date

Select **DATE** from the **DATE & TIME** menu and, using the cursor keys, change the date as shown below. The **up ▲** and **down ▼** keys change the numerical value of the selected digit (indicated by the underline cursor) and the **left ◀** and **right ▶** keys select the required digit position.

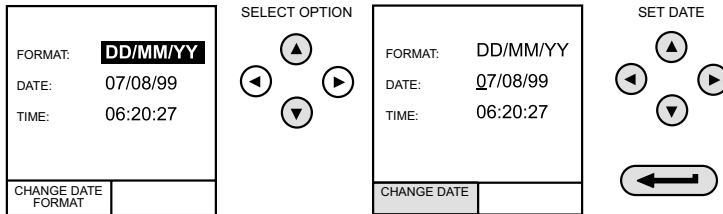

7.5.3 Set Time

Select **TIME** from the **DATE & TIME** menu and, using the cursor keys, change the time as shown below. The **up ▲** and **down ▼** keys change the numerical value of the selected digit (indicated by the underline cursor) and the **left ◀** and **right ▶** keys select the required digit position.

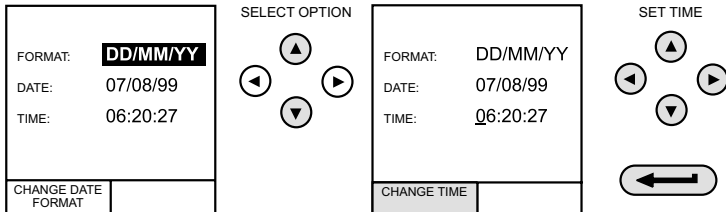

8. Calibration

8.1 General

The instrument is supplied by the manufacturer, complete with calibration certificate(s). A calibration period of 12 months is recommended. The actual calibration interval depends on instrument usage and the total measurement uncertainty acceptable for the specified application.

The DPI 610 IS and DPI 615 IS are very precise measuring instruments and the test equipment and conditions of test must be suitable for the type of work. A Class A compensated deadweight tester must be used. The calibration check and calibration adjustment should be carried out in a controlled environment by a calibration technician*.

The manufacturer offers a comprehensive and, if required, UKAS accredited calibration service.

8.2 Calibration Check

At the chosen calibration interval, the instrument readings should be compared with a known pressure standard.

The recommended method starts at 0, increasing in 20% steps to 100% full-scale and then decreasing in 20% steps to 0.

Note any deviations between the instrument and the pressure standard and consider traceability (accuracy to a National Standard).

If, after a calibration check, the results exceed the tolerance in the specification (or other suitable performance standard), carry out a calibration adjustment.

8.3 Calibration Adjustment

If the instrument is operating correctly, only zero and full-scale calibration will vary. Any excessive non-linearity or temperature effects indicate a fault. The instrument should be returned to a qualified service agent.

8.4 Guide to Calibration Procedures

- Use high quality repeatable and linear pressure sources and allow adequate thermal stabilization time before calibration (minimum 1 hour).
- Conduct the calibration in a temperature controlled and preferably, humidity controlled environment. Recommended temperature is $21^{\circ}\text{C} \pm 2^{\circ}\text{C}$ ($70^{\circ}\text{F} \pm 4^{\circ}\text{F}$).
- Use deadweight testers carefully and away from drafts.
- Review and become familiar with the whole calibration procedure before commencing the calibration process.
- The calibration routines cannot be accessed when the instrument is in **BASIC** mode. Use the **TASK** key to select another mode, e.g. **ADVANCED** before accessing the **CALIBRATION** mode.

* A calibration technician must have the necessary technical knowledge, documentation, special test equipment and tools to carry out the calibration work on this equipment.

8.5 Test Equipment

The calibration procedures require the following test equipment.

Table 8-1: Calibration Equipment Specifications

Test Equipment and Instrument Parameter/Range	Calibration Equipment Accuracy	Calibration Uncertainty
Digital Voltmeter - 5 V input	$\pm 30 \text{ ppm}^a \pm 1 \text{ digit}$	$\pm 10 \text{ ppm}^a \pm 5 \text{ } \mu\text{V}$
Digital Voltmeter - 30 V input	$\pm 45 \text{ ppm}^a \pm 1 \text{ digit}$	$\pm 11 \text{ ppm}^a \pm 110 \text{ } \mu\text{V}$
Digital Ammeter - 55 mA input	$\pm 150 \text{ ppm}^a \pm 4 \text{ digit}$	$\pm 100 \text{ ppm}^a \pm 1 \text{ nA}$
Digital Ammeter - 24 mA output	$\pm 150 \text{ ppm}^a \pm 4 \text{ digit}$	$\pm 160 \text{ ppm}^a \pm 1 \text{ nA}$
Precision thermometer - ambient temperature	$\pm 0.2^\circ\text{C}$	$\pm 0.1^\circ\text{C} \pm 1 \text{ digit}$
Deadweight tester - pressure internal/external	Class A deadweight	$< 0.025\%$

a. ppm = parts per million

Table 8-2: Internal/External Pressure Transducer Verification

Nominal Applied Value as a Percentage of \pm Full-scale	Permissible Deviation
0% (10% for absolute ranges)	$\pm 0.025\% \text{ FS}$
20%	$\pm 0.025\% \text{ FS}$
40%	$\pm 0.025\% \text{ FS}$
60%	$\pm 0.025\% \text{ FS}$
80%	$\pm 0.025\% \text{ FS}$
100%	$\pm 0.025\% \text{ FS}$
80%	$\pm 0.025\% \text{ FS}$
60%	$\pm 0.025\% \text{ FS}$
40%	$\pm 0.025\% \text{ FS}$
20%	$\pm 0.025\% \text{ FS}$
0% (10% for absolute ranges)	$\pm 0.025\% \text{ FS}$

8.6 Using the Calibration Menu

The calibration routines are selected from the Settings menu as detailed in Section 7.4. Enter the calibration PIN code, initially set to 4321, press  and the display shows the calibration menu.

8.7 PIN security

To prevent unauthorized access, it is recommended that the PIN code be changed as soon as possible.

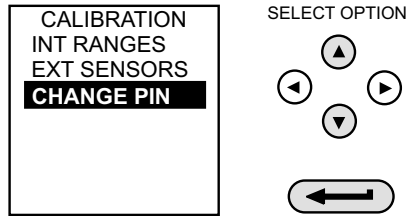

8.7.1 Change PIN

To change the PIN code, select **CHANGE PIN** from the calibration menu and proceed as follows:

Note: To set and verify a new PIN, the new PIN code must be entered twice.

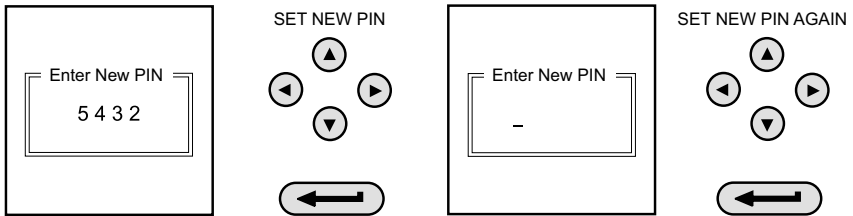

If the second code entered differs from the first, the new PIN will not be set.



8.8 Calibrate Internal Ranges

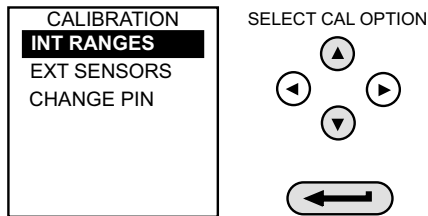

Select the **INT RANGES** from the menu as shown above and follow the calibration procedure on the display.

8.9 Internal Pressure Range

Use the following procedure for calibrating the internal pressure range:

Note: If calibrating the hydraulic calibrator version, the calibrator must first be primed as detailed in Section 9.

1. Connect the outlet port of the instrument to a pressure standard.
2. Allow the instrument's temperature to stabilize for a minimum of 1 hour.

Chapter 8. Calibration

- Switch the instrument on, enter **CALIBRATION** mode and select **INT RANGES** from the **CALIBRATION** menu and then **PRESSURE INT.**

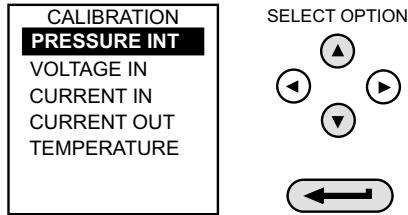

- Apply zero pressure and store the zero point:

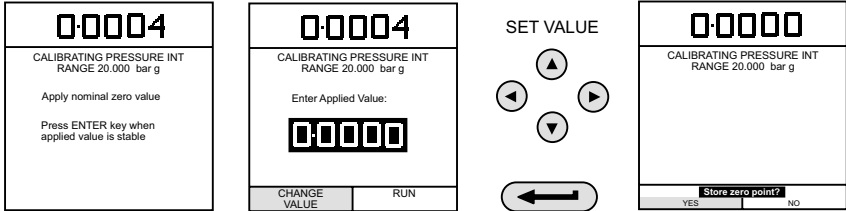

- Close the vent valve, apply full-scale pressure and store the full-scale point:

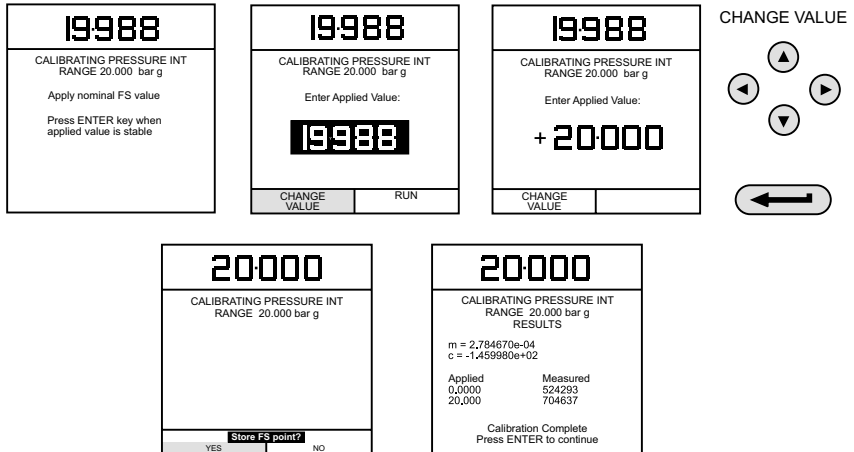

- Press the **ENTER** key to accept the calibration. Press the **EXIT** key four times to quit **CALIBRATION** and **SETUP** modes.
- Check calibration by applying test pressures in Table 8.6 on page 40.

8.10 Voltage Input Range (5 V)

Use the following procedure for calibrating the internal 5 V range:

- Switch the instrument on, enter **CALIBRATION** mode and select **INT RANGES** from the **CALIBRATION** menu shown in Section 8.8.

- Select 5 V range for calibration:

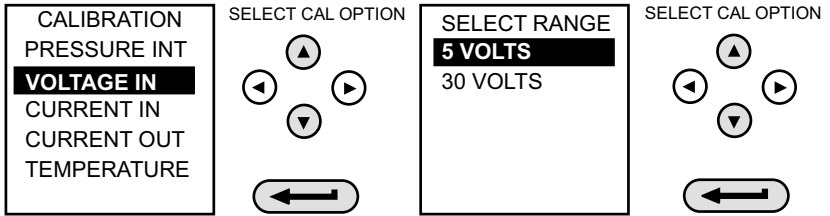

- Link the voltage input terminals with a short lead and enter the zero point:

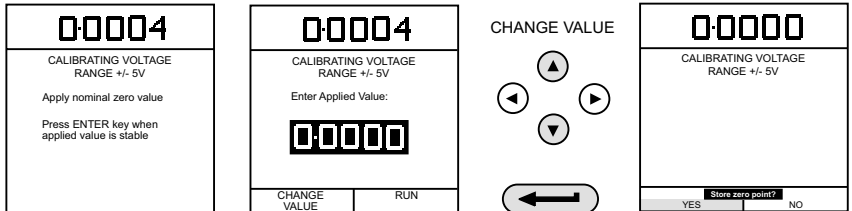

- Remove the shorting link from the voltmeter terminals, connect the V_{in} terminals of the instrument to a variable voltage source and connect a digital voltmeter across the source:

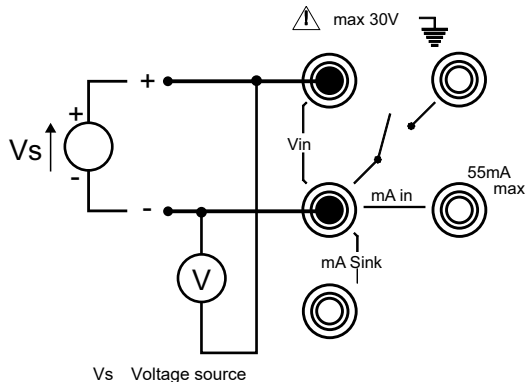

Figure 8-1: 5 V Input Range Calibration Circuit

Chapter 8. Calibration

- Set the variable supply voltage to $5\text{ V} \pm 0.1\text{ V}$ and enter the measured full-scale voltage applied:

Diagram illustrating the calibration steps for a 5V range:

- Panel 1: CALIBRATING VOLTAGE RANGE +/- 5V. Display: 49884. Instruction: Apply nominal FS value. Press ENTER key when applied value is stable.
- Panel 2: CALIBRATING VOLTAGE RANGE +/- 5V. Enter Applied Value: 5.0000.
- Panel 3: CALIBRATING VOLTAGE RANGE +/- 5V. Enter Applied Value: + 49844.
- Panel 4: CALIBRATING VOLTAGE RANGE +/- 5V. Display: 49844. Prompt: Store FS point? (YES/NO).
- Panel 5: CALIBRATING VOLTAGE RANGE +/- 5V RESULTS. Results: $m = 1.395879e-05$, $c = -7.128004e+00$. Applied: 0.0000, 4.9844. Measured: 524360, 875081. Calibration Complete. Press ENTER to continue.

- Press the **ENTER** key to accept the calibration. Press the **EXIT** key once to return to the calibration menu or four times to quit the **CALIBRATION** and **SETUP** modes.
- Verify the instrument calibration by applying the test voltages given in Table 8-3 on page 46, to the voltmeter (after both voltage ranges have been calibrated).
- Disconnect the calibration/test equipment.

8.11 Voltage Input Range (30 V)

Use the following procedure for calibrating the internal 30 V range:

- Switch the instrument on, enter **CALIBRATION** mode and select **INT RANGES** from the **CALIBRATION** menu as shown in Section 8.8.
- Select 30 V range for calibration:

Diagram illustrating the selection of the 30V range for calibration:

- Panel 1: CALIBRATION PRESSURE INT. VOLTAGE IN (highlighted). CURRENT IN. CURRENT OUT. TEMPERATURE.
- Panel 2: SELECT CAL OPTION. 5 VOLTS. 30 VOLTS (highlighted).
- Panel 3: SELECT CAL OPTION. 5 VOLTS. 30 VOLTS (highlighted).

- Link the voltage input terminals with a short lead and enter the zero point:

Diagram illustrating the zeroing process for the 30V range:

- Panel 1: CALIBRATING VOLTAGE RANGE +/- 30V. Display: 0.0004. Instruction: Apply nominal zero value. Press ENTER key when applied value is stable.
- Panel 2: CALIBRATING VOLTAGE RANGE +/- 30V. Enter Applied Value: 0.0000.
- Panel 3: SET VALUE. (Control pad shown).
- Panel 4: CALIBRATING VOLTAGE RANGE +/- 30V. Display: 0.0000. Prompt: Store zero point? (YES/NO).

- Remove the shorting link from the voltmeter terminals, connect the V_{in} terminals of the instrument to a variable voltage source and connect a digital voltmeter across the source:

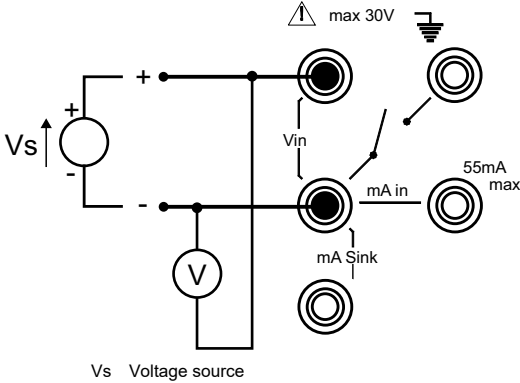

Figure 8-2: 30 V Input Range Calibration Circuit

- Set the variable supply voltage to $30\text{ V} \pm 0.1\text{ V}$ and enter the measured full-scale voltage:

<p style="text-align: center; font-size: 24pt; font-weight: bold;">29984</p> <p style="text-align: center; font-size: 10pt;">CALIBRATING VOLTAGE RANGE +/- 30V</p> <p style="text-align: center; font-size: 8pt;">Apply nominal FS value</p> <p style="text-align: center; font-size: 8pt;">Press ENTER key when applied value is stable</p>	<p style="text-align: center; font-size: 24pt; font-weight: bold;">29984</p> <p style="text-align: center; font-size: 10pt;">CALIBRATING VOLTAGE RANGE +/- 30V</p> <p style="text-align: center; font-size: 8pt;">Enter Applied Value:</p> <p style="text-align: center; font-size: 18pt; font-weight: bold;">30.000</p> <p style="text-align: center; font-size: 8pt;">CHANGE VALUE RUN</p>	<p>SET VALUE</p> <p>▲</p> <p>◀ ▶</p> <p>▼</p> <p>←</p>	<p style="text-align: center; font-size: 24pt; font-weight: bold;">29984</p> <p style="text-align: center; font-size: 10pt;">CALIBRATING VOLTAGE RANGE +/- 30V</p> <p style="text-align: center; font-size: 8pt;">Enter Applied Value:</p> <p style="text-align: center; font-size: 18pt; font-weight: bold;">29984</p> <p style="text-align: center; font-size: 8pt;">CHANGE VALUE RUN</p>						
<p style="text-align: center; font-size: 24pt; font-weight: bold;">29984</p> <p style="text-align: center; font-size: 10pt;">CALIBRATING VOLTAGE RANGE +/- 30V</p> <p style="text-align: center; font-size: 8pt; border: 1px solid black; display: inline-block;">Store FS point?</p> <p style="text-align: center; font-size: 8pt;">YES NO</p>	<p style="text-align: center; font-size: 24pt; font-weight: bold;">29984</p> <p style="text-align: center; font-size: 10pt;">CALIBRATING VOLTAGE RANGE +/- 30V RESULTS</p> <p style="font-size: 8pt;">m = 1.395879e-05 c = -7.128004e+00</p> <table style="font-size: 8pt; width: 100%;"> <tr> <td>Applied</td> <td>Measured</td> </tr> <tr> <td>0.0000</td> <td>526380</td> </tr> <tr> <td>29.984</td> <td>873988</td> </tr> </table> <p style="text-align: center; font-size: 8pt;">Calibration Complete Press ENTER to continue</p>	Applied	Measured	0.0000	526380	29.984	873988		
Applied	Measured								
0.0000	526380								
29.984	873988								

- Press the **ENTER** key to accept the calibration. Press the **EXIT** key four times to quit the **CALIBRATION** and **SETUP** modes.
- Verify the instrument calibration by applying the test voltages given in Table 8-3 on page 46 to the voltmeter (after both voltage ranges have been calibrated).
- Disconnect the calibration/test equipment.

Table 8-3: Electrical Voltage Input Calibration Tolerances

Voltage Calibration 30 V Range Verification Tolerances		Voltage Calibration 5 V Range Verification Tolerances	
Applied Voltage	Permissible Deviation	Applied Voltage	Permissible Deviation
-30	± 0.05% rdg, ± 0.004% FS	-5	± 0.05% rdg, ± 0.004% FS
-24	± 0.05% rdg, ± 0.004% FS	-4	± 0.05% rdg, ± 0.004% FS
-18	± 0.05% rdg, ± 0.004% FS	-3	± 0.05% rdg, ± 0.004% FS
-12	± 0.05% rdg, ± 0.004% FS	-2	± 0.05% rdg, ± 0.004% FS
-6	± 0.05% rdg, ± 0.004% FS	-1	± 0.05% rdg, ± 0.004% FS
0	± 0.05% rdg, ± 0.004% FS	0	± 0.05% rdg, ± 0.004% FS
6	± 0.05% rdg, ± 0.004% FS	1	± 0.05% rdg, ± 0.004% FS
12	± 0.05% rdg, ± 0.004% FS	2	± 0.05% rdg, ± 0.004% FS
18	± 0.05% rdg, ± 0.004% FS	3	± 0.05% rdg, ± 0.004% FS
24	± 0.05% rdg, ± 0.004% FS	4	± 0.05% rdg, ± 0.004% FS
30	± 0.05% rdg, ± 0.004% FS	5	± 0.05% rdg, ± 0.004% FS

8.12 Current Input Range (55 mA)

Use the following procedure for calibrating the current input range:

1. Switch the instrument on, enter **CALIBRATION** mode and select **INT RANGES** from the **CALIBRATION** menu as shown in Section 8.8.
2. Select **CURRENT IN** range for calibration:

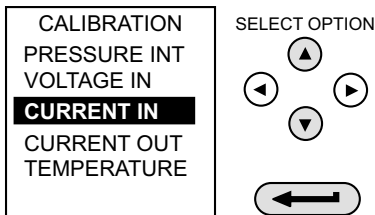

3. Open circuit the **mA IN** terminals and enter the zero point:

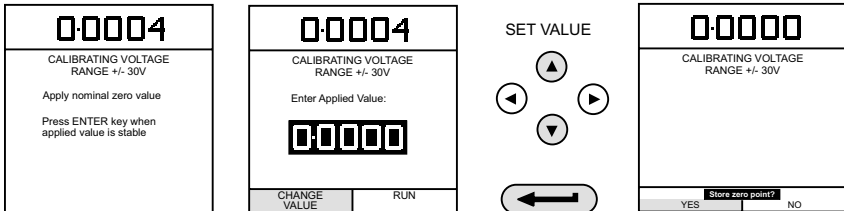

- Connect the mA in terminals of the instrument to a variable current source and connect a digital ammeter in series with the supply:

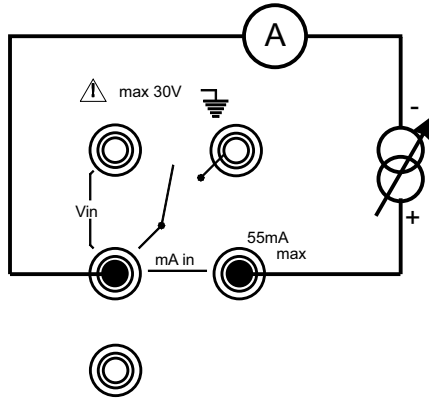

Figure 8-3: 55 mA Current Input Range Calibration Circuit

- Set the input current to 55 ± 0.1 mA and enter the measured full-scale input current:

<p>54984</p> <p>CALIBRATING CURRENT RANGE +/- 55 mA</p> <p>Apply nominal FS value Press ENTER key when applied value is stable</p>	<p>54984</p> <p>CALIBRATING CURRENT RANGE +/- 55 mA</p> <p>Enter Applied Value:</p> <p>55000</p> <p>CHANGE VALUE RUN</p>	<p>54984</p> <p>CALIBRATING CURRENT RANGE +/- 55 mA</p> <p>Enter Applied Value:</p> <p>+ 54944</p> <p>CHANGE VALUE</p>	<p>CHANGE VALUE</p> <p>▲</p> <p>◀ ▶</p> <p>▼</p> <p>←</p>				
<p>54984</p> <p>CALIBRATING CURRENT RANGE +/- 55 mA</p> <p>Store FS point?</p> <p>YES NO</p>	<p>54984</p> <p>CALIBRATING CURRENT RANGE +/- 55 mA</p> <p>RESULTS</p> <p>m = 2.784670e-04 c = -1.459980e+02</p> <table border="1"> <tr> <td>Applied</td> <td>Measured</td> </tr> <tr> <td>0.0000</td> <td>524293</td> </tr> <tr> <td>54.984</td> <td>704637</td> </tr> </table> <p>Calibration Complete Press ENTER to continue</p>	Applied	Measured	0.0000	524293	54.984	704637
Applied	Measured						
0.0000	524293						
54.984	704637						

- Press the **ENTER** key to accept the calibration. Press the **EXIT** key four times to quit the **CALIBRATION** and **SETUP** modes.
- Verify the instrument calibration by applying the test currents given in Table 8-4 on page 48 to the ammeter.
- Disconnect the calibration/test equipment.

Table 8-4: Electrical Current Input Calibration Tolerances

Current Calibration, 55 mA Range Verification Tolerances	
Applied Current (mA)	Permissible Deviation
-55	$\pm 0.05\% \text{ rdg} \pm 0.004\% \text{ FS}$
-45	$\pm 0.05\% \text{ rdg} \pm 0.004\% \text{ FS}$
-35	$\pm 0.05\% \text{ rdg} \pm 0.004\% \text{ FS}$
-25	$\pm 0.05\% \text{ rdg} \pm 0.004\% \text{ FS}$
-15	$\pm 0.05\% \text{ rdg} \pm 0.004\% \text{ FS}$
-5	$\pm 0.05\% \text{ rdg} \pm 0.004\% \text{ FS}$
0	$\pm 0.05\% \text{ rdg} \pm 0.004\% \text{ FS}$
5	$\pm 0.05\% \text{ rdg} \pm 0.004\% \text{ FS}$
15	$\pm 0.05\% \text{ rdg} \pm 0.004\% \text{ FS}$
25	$\pm 0.05\% \text{ rdg} \pm 0.004\% \text{ FS}$
35	$\pm 0.05\% \text{ rdg} \pm 0.004\% \text{ FS}$
45	$\pm 0.05\% \text{ rdg} \pm 0.004\% \text{ FS}$
55	$\pm 0.05\% \text{ rdg} \pm 0.004\% \text{ FS}$

8.13 Current Output Range (24 mA)

Use the following procedure for calibrating the current output range:

1. Switch the instrument on, enter **CALIBRATION** mode and select **INT RANGES** from the **CALIBRATION** menu as shown in Section 8.8.
2. Select **CURRENT OUT** range for calibration:

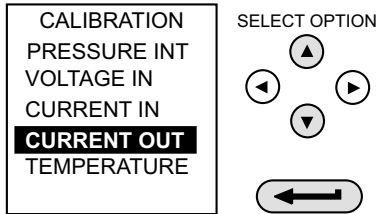

3. Connect a digital ammeter to the instrument as shown below.

Note: This procedure requires an external supply.

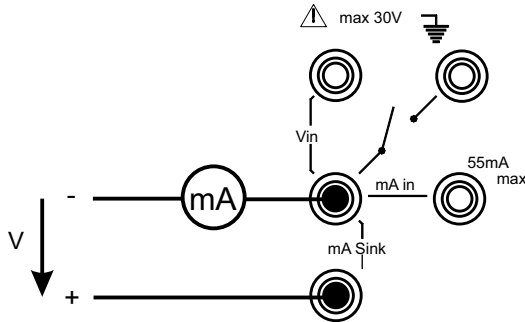

Figure 8-4: 24 mA Current Output Range Calibration Circuit

4. Measure the 10% full-scale output current and enter the value measured on the external ammeter:

2.453	2.453	2.453	CHANGE VALUE
CALIBRATING CURRENT RANGE 0-24 mA Measure 10% FS output Press ENTER key when applied value is stable	CALIBRATING CURRENT RANGE 0-24 mA Enter Measured Current: <div style="border: 1px solid black; padding: 2px; display: inline-block; font-family: monospace; font-size: 12pt;">0.0000</div>	CALIBRATING CURRENT RANGE 0-24 mA Enter Measured Current: + 2.458	
CHANGE VALUE RUN	CHANGE VALUE RUN	CHANGE VALUE RUN	

5. Measure the 90% full-scale output current and enter the value measured on the external ammeter

2.458	21.558	21.558
CALIBRATING CURRENT RANGE 0-24 mA Measure 90% FS - output Press ENTER key when applied value is stable	CALIBRATING CURRENT RANGE 0-24 mA Enter Measured Current: <div style="border: 1px solid black; padding: 2px; display: inline-block; font-family: monospace; font-size: 12pt;">21.558</div>	CALIBRATING CURRENT RANGE 0-24 mA Enter Measured Current: <div style="border: 1px solid black; padding: 2px; display: inline-block; font-family: monospace; font-size: 12pt;">21.558</div>
Store Cal point? YES NO	CHANGE VALUE RUN	CHANGE VALUE RUN

21.558	CHANGE VALUE 	21.551	21.551
CALIBRATING CURRENT RANGE 0-24 mA Enter Measured Current: + 21.551		CALIBRATING CURRENT RANGE 0-24 mA Store Cal point? YES NO	CALIBRATING CURRENT RANGE 0-24 mA RESULTS m = 2.784670e-04 c = -1.459980e+02 m2 = -2.781021e-04 c2 = 8.814727e+02 Applied Measured 2.458 547315 54.984 726779 Calibration Complete Press ENTER to continue
CHANGE VALUE RUN		CHANGE VALUE RUN	CHANGE VALUE RUN

6. Press the **ENTER** key to accept the calibration. Press the **EXIT** key four times to quit the **CALIBRATION** and **SETUP** modes.
7. Verify the instrument's output current calibration by setting up the loop test currents as shown in Table 8-5 on page 50 and checking the set values against the ammeter standard.

Chapter 8. Calibration

8. Connect an external voltage source shown in Figure 8-4 on page 49, press the **OUTPUT** key, select **mA Value**:

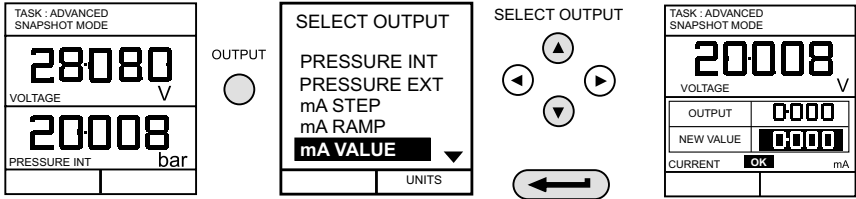

9. Set the loop output current to 5 mA as shown below and check that the output current, measured by the ammeter standard is within the limits given in Table 8-5 on page 50.

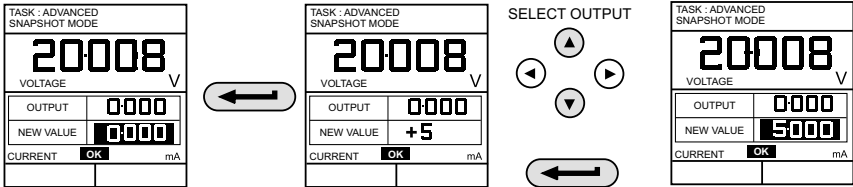

10. Repeat (9) for all output values given in Table 8-5 on page 50.

Table 8-5: Electrical Current Output Calibration Tolerances

Current Output Calibration, 24 mA Range Verification Tolerances	
Applied Current (mA)	Permissible Deviation
0	$\pm 0.05\% \text{ rdg} \pm 0.01\% \text{ FS}$
5	$\pm 0.05\% \text{ rdg} \pm 0.01\% \text{ FS}$
10	$\pm 0.05\% \text{ rdg} \pm 0.01\% \text{ FS}$
15	$\pm 0.05\% \text{ rdg} \pm 0.01\% \text{ FS}$
20	$\pm 0.05\% \text{ rdg} \pm 0.01\% \text{ FS}$
24	$\pm 0.05\% \text{ rdg} \pm 0.01\% \text{ FS}$
20	$\pm 0.05\% \text{ rdg} \pm 0.01\% \text{ FS}$
15	$\pm 0.05\% \text{ rdg} \pm 0.01\% \text{ FS}$
10	$\pm 0.05\% \text{ rdg} \pm 0.01\% \text{ FS}$
5	$\pm 0.05\% \text{ rdg} \pm 0.01\% \text{ FS}$
0	$\pm 0.05\% \text{ rdg} \pm 0.01\% \text{ FS}$

11. Disconnect the calibration/test equipment.

8.14 Ambient Temperature Channel

Use the following procedure for calibrating the ambient temperature measurement channel:

- Switch the instrument on, enter the **CALIBRATION** mode and select **TEMPERATURE**:

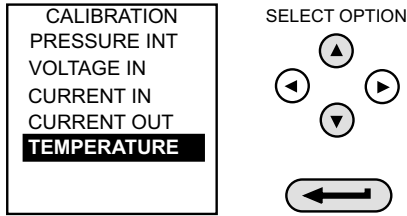

- Allow the instrument's temperature to stabilize in the calibration environment for at least one hour.
- Read the environmental temperature on a calibrated digital thermometer and enter the recorded value as shown below. Example shown for a measured ambient temperature of 21.5°C.

Note: Only one temperature point is required.

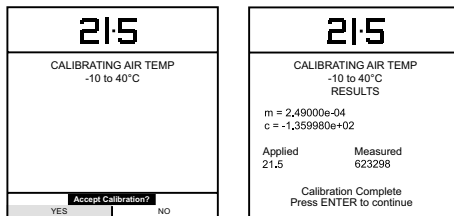
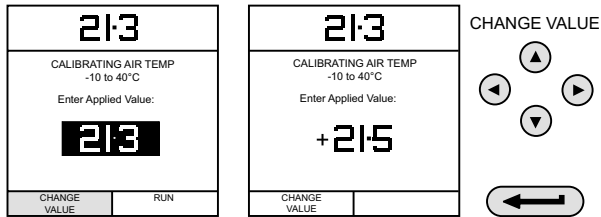

- Press the **ENTER** key to accept the calibration. Press the **EXIT** key once to return to the calibration menu or four times to quit the **CALIBRATION** and **SETUP** modes.

8.15 Calibrate External Sensors

Use the following procedure for calibrating external pressure sensors:

- Connect the required external transducer to the EXT TRANSDUCER socket located on the rear of the instrument.
- Allow the instrument's temperature and the temperature of the external transducer to stabilize in the calibration environment for a minimum of 1 hour.

Chapter 8. Calibration

- Switch the instrument on, enter **CALIBRATION** mode and select **EXT SENSORS** from the **CALIBRATION** menu:

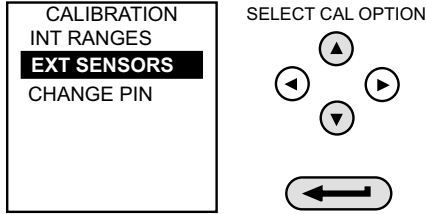

- Select the transducer to be calibrated from the transducer menu using the cursor keys and press **ENTER**:

If the sensor to be calibrated is not in the directory, or no sensors are listed in the directory, press the **F1** key (**ADD NEW SENSOR**). This will place the sensor in the directory, allowing it to then be selected.

- Connect the pressure standard to the inlet of the external transducer, apply the zero point pressure and store the zero point:

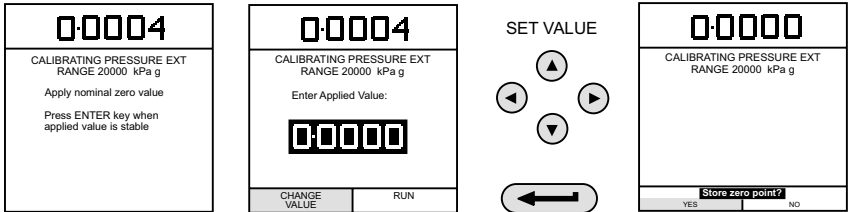

- Apply the full-scale pressure to the external transducer and store the full-scale (FS) point

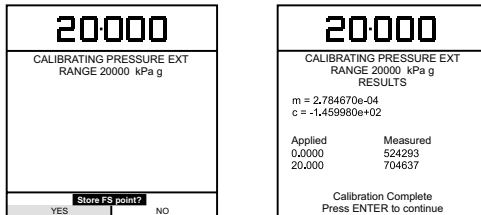
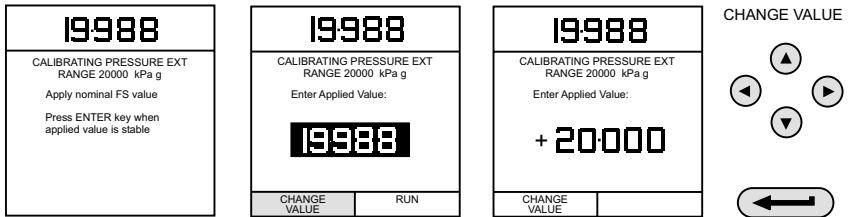

- Release the applied pressure and disconnect the pressure reference. Press the **ENTER** key to accept the calibration. Press the **EXIT** key once to return to the calibration menu or four times to quit the **CALIBRATION** and **SETUP** modes.
- Check the calibration of the external transducer by applying the test pressures as detailed in Table 8.6 on page 40.

8.16 Add External Sensor

To add an external sensor to the directory of external sensors, proceed as follows:

- Connect the required external transducer to the EXT TRANSDUCER socket located on the rear of the instrument.

EXT SENSORS		
SERIAL No.	RANGE	TYPE
	bar	

ADD NEW SENSOR	
----------------	--

EXT SENSORS		
SERIAL No.	RANGE	TYPE
1154738	20,000	g

ADD NEW SENSOR	EDIT
----------------	------

EXT SENSORS		
SERIAL No.	RANGE	TYPE
1154738	20,000	g

REMOVE	CHANGE DETAILS
--------	----------------

Digitally compensated transducers will be downloaded into the directory as soon as the F1 key is operated. Data for other types can be edited by selecting **EDIT** (F2). If the data cannot be edited a warning message (INVALID ACTION) is displayed.

9. Hydraulic Calibrator Versions

9.1 Introduction

These versions of the DPI 610 and DPI 615 intrinsically safe calibrators provide manual generation of hydraulic pressure and consist of a screw-press with a priming pump and isolation valve.

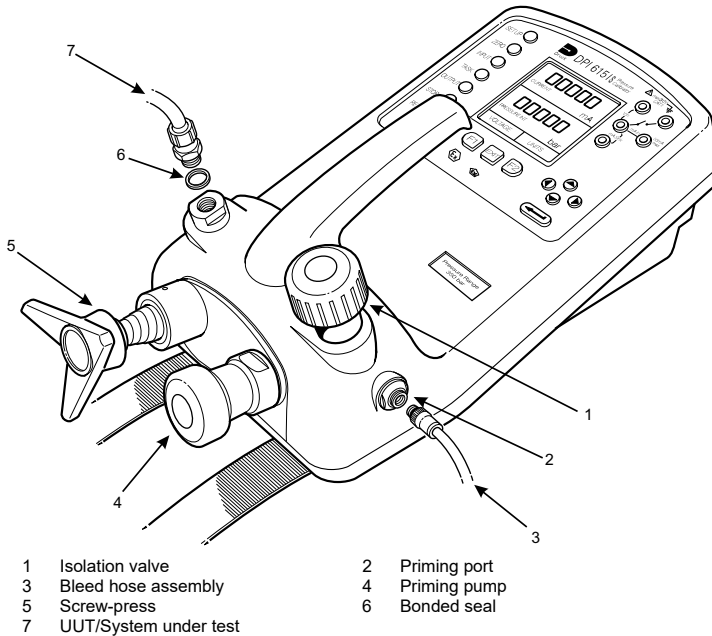

Figure 9-1: DPI 610/615 IS HC Connections

The internal hydraulic parts are brass, stainless steel, copper, nylon and fluorocarbon rubber (Viton). The hydraulic fluid can be either demineralized water or one of the hydraulic fluids listed below:



CAUTION Only use the recommended hydraulic fluids.
Do not mix hydraulic fluids.

Table 9-1: Recommended Hydraulic Fluids

ISO 3448 Viscosity Grade	Approximate SAE Viscosity Classification	Shell	Esso (Exxon)	Mobil
VG10	5W	Tellus R10	Nuto H10	Velocite No. 6
VG15		Tellus T15 Tellus V15	Nuto H15	

Table 9-1: Recommended Hydraulic Fluids

ISO 3448 Viscosity Grade	Approximate SAE Viscosity Classification	Shell	Esso (Exxon)	Mobil
VG22		Tellus 22 Tellus R22	Nuto H22	DTE 22
VG32	10W	Tellus V32	Nuto H32	DTE Oil Light DTE 24
VG37		Tellus 37 Tellus R37 Tellus T37 Tellus V37		

9.2 Safety Instructions



WARNING Hydraulic fluid is injurious. Observe relevant health and safety precautions. Use appropriate protective barriers and eye protection.

Before applying pressure, examine all fittings and equipment for damage and ensure that all equipment is to the correct pressure rating.

Do not exceed the maximum working pressure of the equipment (indicated on start-up screen at switch-on).



CAUTION Observe absolute cleanliness when using the instrument. Severe damage can be caused if equipment connect to this instrument is contaminated. Connect only clean equipment to the instrument. To avoid any contamination, an external filter is recommended.

9.3 Preparation for Use

- Use an appropriate seal and connect the bleed hose assembly (3) to the priming port.
- Make sure that the screw-press (5) is wound fully in (clockwise).
- Make sure that the isolation valve (1) is open (fully counter clockwise).
- Use a bonded seal (6) and connect the unit or system under test (7) to the pressure port.



WARNING Make sure that the connecting line to the external device or system is capable of withstanding the line pressure to be applied.

Note: A bleed point must be provided on the external device.

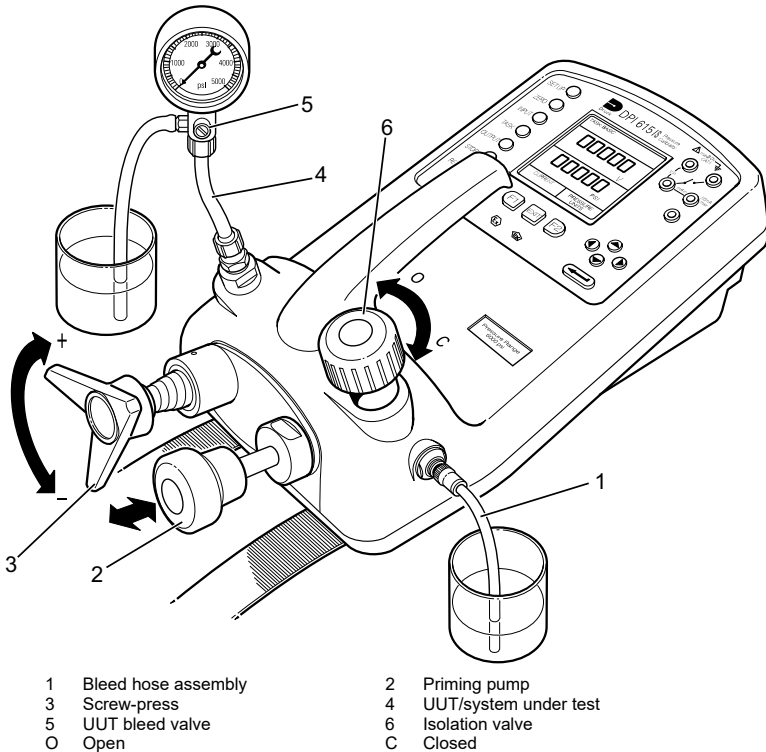

Figure 9-2: Priming/Test Set-up

9.4 Bleeding the System

Before any measurements can be made, the hydraulic system needs to be primed and bled free of air. During the following operations, prepare for fluid spillage and provide a suitable receptacle for collecting the spillage.

1. Prepare for use as detailed in Section 9.3.
2. Fill a suitable container with clean hydraulic fluid and place the bleed hose assembly (1) connected to the priming port into the fluid.
3. Open the UUT bleed valve (5) and, if possible, fit a hose to the bleed point and locate the hose end in a container of the same hydraulic fluid.
4. Use the priming pump (2), to pump hydraulic fluid into the instrument and the connected system. Monitor the hydraulic fluid level, ensuring that the bleed hose assembly (1) stays below the fluid level and is not allowed to suck in air. Top-up hydraulic fluid level as necessary.
5. Continue use of the priming pump (2) until only hydraulic fluid and no air is expelled from the bleed point.
6. Close the UUT bleed valve (5) when the priming pump (2) is at the bottom of its stroke (fully pushed in) and slowly wind out the screw-press (3) to its fullest extent to draw in further hydraulic fluid (approx. 7 cm³ or 0.43 in³).

Chapter 9. Hydraulic Calibrator Versions

7. Switch the instrument **ON** and, still using the priming pump (2), pressurize the system to approximately 2 bar (30 psi).
8. Close the isolation valve (6) disconnect the bleed hose assembly (1) from the priming port.

9.5 Operation

To obtain a pressure reading, proceed as follows:

1. Switch the instrument **ON** and select the required **TASK**.
2. Rotate the screw-press clockwise to increase the applied pressure.
Note: When hydraulic fluid is compressed and flows through a restriction, there is an increase in temperature that affects the pressure. Allow sufficient time for this pressure reading to stabilize before recording or logging a reading.
3. After testing, reduce the pressure in the system to zero by turning the screw-press counter clockwise. Before disconnecting the UUT, open the isolation valve.
4. Remove the connection to the UUT and fit a blanking plug into the instrument's pressure port. Clean any spilled fluid off the instrument case.

9.6 Draining the Hydraulic Fluid

To drain the hydraulic fluid from the instrument, proceed as follows:

1. Turn the isolation valve (4) fully counter clockwise. Turn the instrument onto the left hand side (pressure port nearest to the work bench). Place receptacle below the pressure port to collect hydraulic fluid.
2. Drain the system by slowly winding in the screw-press (3) and then depressing the priming pump (2) plunger to expel any fluid remaining in the instrument.
3. If necessary, apply an air line to the priming port to clear any remaining fluid out of the instrument.

9.7 Flushing - Refilling or Changing the Hydraulic Fluid

If necessary, to remove any contaminants, flush out the hydraulic system as follows:

Flushing - Refilling or Changing the Hydraulic Fluid

1. Connect the bleed hose assembly (1) to the priming port and a bleed hose to the pressure port as shown below:

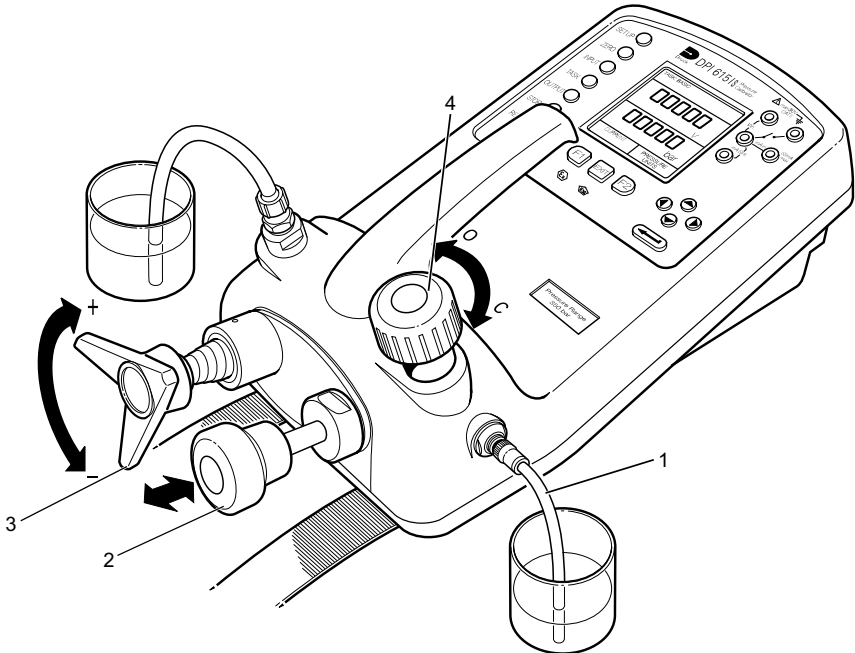

1	Bleed hose assembly	2	Priming pump
3	Screw-press	4	Isolation valve
O	Open	C	Closed

Figure 9-3: Flushing/Filling Connections

2. Fill the priming fluid container with clean hydraulic fluid of the required type. Use the priming pump (2), to pump fresh hydraulic fluid through the system until clean hydraulic fluid, free of air bubbles, emerges into the container at the output port. Discard the contaminated fluid expelled during this process.
3. Remove the bleed hose assembly (1) located to the output port and, to prevent the ingress of any contaminant, fit a blanking plug in its place.
4. Close the isolation valve (4) and remove the bleed hose assembly (1) from the priming inlet.
5. Clean off any surplus oil that may have spilled onto the instrument casing.

The instrument is now ready for operation or storage. If storing, apply a label detailing the type of hydraulic fluid contained in the instrument.

Note: For long term storage, it is recommended that the instrument be drained and stored empty.

Appendix A. Datalog File Example

A.1 Typical Uploaded Data Log File (DPI 610)

The following gives details of a typical data file upload:

FILENAME: TEST 5
 DATE: 21/10/2006
 TIME: 15:58
 TRIGGER: KEYPRESS
 AMBIENT TEMP: 24.1 C

NO. OF POINTS 11
 RECORD TYPE 0
 CURRENT mA PRESSURE INT bar

3.902	0.008	-0.65 %span	21/10/2006	15:58:55
6.076	2.311	1.42 %span	21/10/2006	16:00:03
7.598	4.404	0.47 %span	21/10/2006	16:00:57
8.085	5.023	0.41 %span	21/10/2006	16:01:45
9.949	7.249	0.94 %span	21/10/2006	16:02:42
13.002	11.300	-0.23 %span	21/10/2006	16:03:30
17.005	16.102	0.77 %span	21/10/2006	16:05:00
17.766	17.106	0.51 %span	21/10/2006	16:06:07
17.812	17.105	0.80 %span	21/10/2006	16:07:49
18.532	17.965	1.00 %span	21/10/2006	16:16:35
20.007	20.212	-1.02 %span	21/10/2006	16:18:23

A.2 Typical Uploaded Procedure Data File (DPI 615)

The following gives details of a typical data file upload:

FILENAME: TEST 6
 DATE: 21/10/2006
 TIME: 15:58
 TRIGGER: KEYPRESS
 AMBIENT TEMP: 24.1 C

NO. OF POINTS 11
 RECORD TYPE 0
 CURRENT mA PRESSURE INT bar

3.902	0.008	-0.65 %span	PASS	21/10/2006	15:58:55
6.076	2.311	1.42 %span	FAIL	21/10/2006	16:00:03
7.598	4.404	0.47 %span	PASS	21/10/2006	16:00:57
8.085	5.023	0.41 %span	PASS	21/10/2006	16:01:45
9.949	7.249	0.94 %span	PASS	21/10/2006	16:02:42
13.002	11.300	-0.23 %span	PASS	21/10/2006	16:03:30
17.005	16.102	0.77 %span	PASS	21/10/2006	16:05:00
17.766	17.106	0.51 %span	PASS	21/10/2006	16:06:07
17.812	17.105	0.80 %span	PASS	21/10/2006	16:07:49
18.532	17.965	1.00 %span	PASS	21/10/2006	16:16:35
20.007	20.212	-1.02 %span	FAIL	21/10/2006	16:18:23

A.3 Record Type

The Record Type number contained in the header is a 16-bit field, with the individual bits representing result formats as detailed below:

Table A-1: Data File Record Types

Record Type	Description
1	P-Display
2	Switch Test
4	Leak Test
8	Input Channel: Min/Max ON
120	Combination of all Input Process Functions
896	Combination of all Output Process Functions
1024	mA Step Mode
2048	mA Value Mode
4096	mA Ramp Mode
8192	No Input Selected
16384	No Output Selected

Appendix B. “Quick Fit” Pressure Connector

B.1 Introduction

The “Quick Fit” pressure connector allows tool free connection of pressure equipment to your pressure instrument. The “Quick Fit” pressure connector should only be tightened by hand and should not be tightened with a tool.



Figure B-1: “Quick Fit” Pressure Connector

To prevent damage to your calibrator please ensure that the sequence of connection to the “Quick Fit” pressure connector is correctly followed as described below.

Where a tool is used to connect to the appropriate “Quick Fit” pressure connector adaptor, the adaptor should be removed from the “Quick Fit” pressure connector using the procedure in Appendix B.2.



Figure B-2: “Quick Fit” Pressure Connector - Adaptor Removed

B.2 Connection Sequence



WARNING Pressurized gases are dangerous. Before you attach or disconnect pressure equipment, safely release all the pressure



CAUTION To prevent damage to the instrument, do not let dirt get into the pressure mechanism. Before you attach equipment, make sure it is clean or use the applicable dirt trap.

Procedure to attach the “Quick Fit” pressure connector:

1. Remove the adaptor from the “Quick Fit” pressure connector.
2. Use an applicable seal for the pressure connection:
 - a. NPT type: Use an applicable sealant on the thread.

Appendix B. “Quick Fit” Pressure Connector

- b. BSP (parallel type, 100 bar (1500 psi) or more): We recommend a bonded seal at the bottom.
 - c. BSP (parallel type, 100 bar (1500 psi) or less): a bonded seal at the top is permitted).
3. Attach the adaptor to the device. If necessary, use one of the alternative adaptor sets, part number IO620-BSP, IO620-NPT or IO620-MET, and tighten to the applicable torque.
 4. Re-attach the adaptor to the “Quick Fit” pressure connector and hand tighten it.

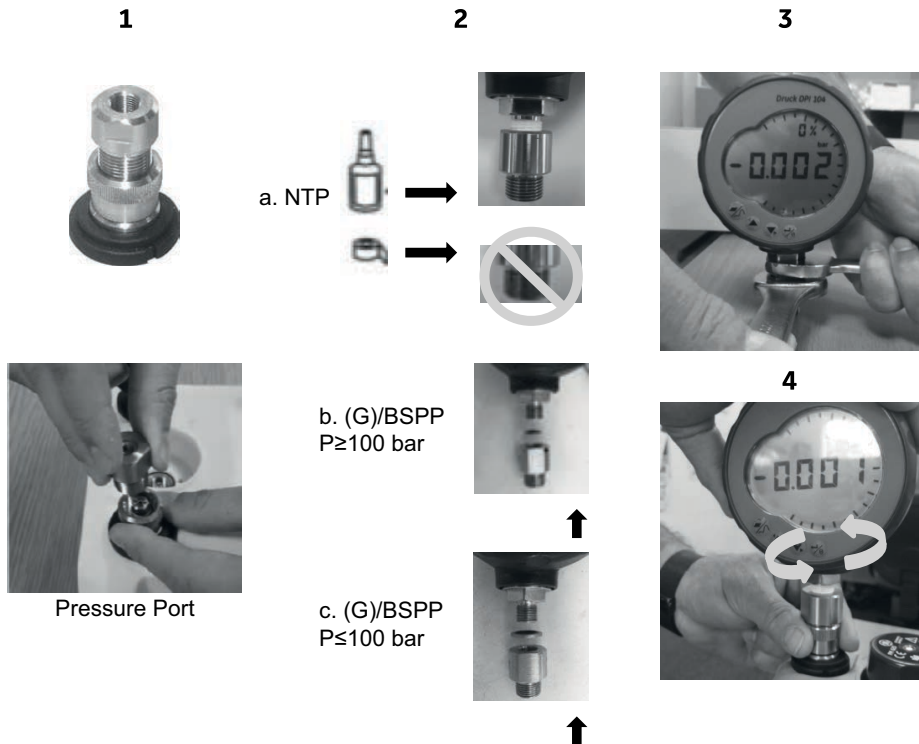

Figure B-3: Remove/Install “Quick Fit” Pressure Connector

Procedure to remove the “Quick Fit” pressure connector:

1. Release the pressure.
2. Remove the adaptor from the “Quick Fit” pressure connector. The adaptor is hand tightened and does not require tools to remove.
3. Remove the adaptor from the device under test; use appropriate tools as necessary.
4. Re-attach the adaptor to the “Quick Fit” pressure connector and hand tighten it.

Office Locations

Headquarters

Leicester, UK

☎ +44 (0) 116 2317233
✉ gb.sensing.sales@bakerhughes.com

Australia

North Sydney

☎ 1300 171 502
✉ custcare.au@bakerhughes.com

China

Beijing

☎ +86 180 1929 3751
✉ fan.kai@bakerhughes.com

China

Guangzhou

☎ +86 173 1081 7703
✉ dehou.zhang@bakerhughes.com

China

Shanghai

☎ +91 9986024426
✉ hensen.zhang@bakerhughes.com

France

Toulouse

☎ +33 562 888 250
✉ sensing.FR.cc@bakerhughes.com

Germany

Frankfurt

☎ +49 (0) 69-22222-973
✉ sensing.de.cc@bakerhughes.com

India

Bangalore

☎ +91 9986024426
✉ aneesh.madhav@bakerhughes.com

Italy

Milan

☎ +39 02 36 04 28 42
✉ csd.italia@bakerhughes.com

Japan

Tokyo

☎ +81 3 6890 4538
✉ gesitj@bakerhughes.com

Netherlands

Hoeveraken

☎ +31 334678950
✉ nl.sensing.sales@bakerhughes.com

Russia

Moscow

☎ +7 915 3161487
✉ aleksey.khamov@bakerhughes.com

UAE

Abu Dhabi

☎ +971 528007351
✉ suhel.aboobacker@bakerhughes.com

USA

Boston

☎ 1-800-833-9438
✉ custcareboston@bakerhughes.com

Services and Support Locations

Tech Support

Global

✉ drucktechsupport@bakerhughes.com

Brazil

Campinas

☎ +55 19 2104 6924, +55 19 97169 1190
✉ cc.sensing.brasil@bakerhughes.com

China

Changzhou

☎ +86 400 818 1099
✉ service.mcchina@bakerhughes.com

France

Toulouse

☎ +33 562 888 250
✉ sensing.FR.cc@bakerhughes.com

India

Pune

☎ +91-2135-620421~425
✉ mcindia.inhouseservice@bakerhughes.com

Japan

Tokyo

☎ +81 3 6894 1838
✉ service.druck.jp@bakerhughes.com

UAE

Abu Dhabi

☎ +971 2 4079381
✉ gulfservices@bakerhughes.com

UK

Leicester

☎ +44 (0) 116 2317107
✉ sensing.grobycc@bakerhughes.com

USA

BillERICA

☎ +1 (281) 542-3650
✉ namservice@bakerhughes.com